

N 50, Induction hob with integrated ventilation system, 60 cm  
T46CB4AX2

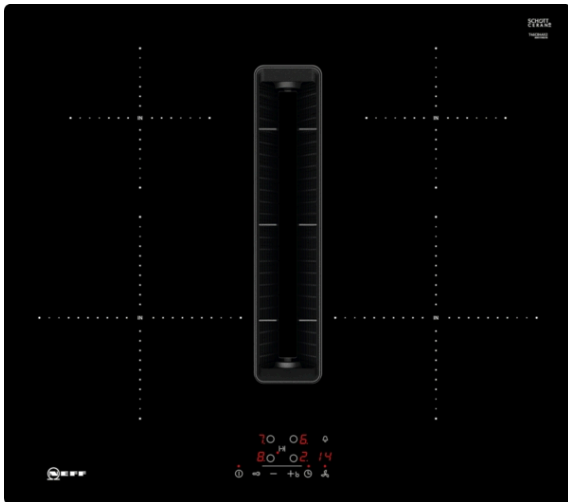

COOKING PASSION SINCE 1877



**B**

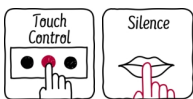

This induction hob with integrated ventilation combines two appliances in one for a clear view while cooking.

- ✓ Touch Control – Control your hob with just one touch and a timer.
- ✓ High Extraction Rate – ensures a clear view while cooking thanks to efficient motor technology.
- ✓ Reduced Noise – our optimized motor guarantees a quiet cooking experience.
- ✓ Easy-clean filters – Easy to remove and dishwasher-safe.
- ✓ Power Boost – An extra surge of heat when you need fast results.

#### Features

##### Technical Data

Product name/family : Cooking zone ceramic  
 Construction type : Built-in  
 Energy input : Electric  
 Required niche size for installation (HxWxD) : 223 x 560-560 x 490-490 mm  
 Width of the appliance : 592 mm  
 Dimensions : 223 x 592 x 522 mm  
 Dimensions of the packed product (HxWxD) : 430 x 690 x 670 mm  
 Net weight : 23.371 kg  
 Gross weight : 27.5 kg  
 Residual heat indicator : Separate  
 Location of control panel : Hob front  
 Basic surface material : Ceramic  
 Color of surface : Black  
 Approval certificates : CE, VDE  
 Length of electrical supply cord : 110 cm  
 Sealed Burners : No  
 heating with booster : All  
 Power of heating element (kW) : 2.2 kW  
 Power of 3rd heating element (kW) : 1.4 kW  
 Power of 5th heating element (kW) : 1.4 kW  
 Power of 3rd heating element (kW in boost) : [2.2] kW  
 Maximum output air extraction : 500 m<sup>3</sup>/h  
 Boost position output recirculating : 600.0 m<sup>3</sup>/h  
 Maximum output recirculating air : 555 m<sup>3</sup>/h  
 Boost position air extraction : 622 m<sup>3</sup>/h  
 Noise level : 69 dB(A) re 1 pW  
 Odour filter : No  
 Operating Mode : Convertible  
 Delay Shut off modes : 30 min  
 Electrical connection rating : 7400 W  
 Voltage : 220-240/380-415 V  
 Frequency : 50; 60 Hz  
 Main colour of product : Black  
 Approval certificates : CE, VDE  
 Length of electrical supply cord : 110 cm  
 Required niche size for installation (HxWxD) : 223 x 560-560 x 490-490 mm  
 Dimensions : 223 x 592 x 522 mm  
 Dimensions of the packed product (HxWxD) : 430 x 690 x 670 mm  
 Net weight : 23.371 kg  
 Gross weight : 27.5 kg

#### Optional accessories

Z811DU0 : Acoustics Filter , Z821PD0 : Basic kit (partly-)ducted recirculation , Z821PD1 : Plinth Diffusor , Z821UD0 : Kit Unducted Recirculation , Z821VR0 : cleanAir recirculation replenishment fil , Z861SB1 : 90° flat duct bend horizontal , Z861SB2 : 90° flat duct L vertical , Z861SB3 : 90° flat duct M vertical , Z861SB4 : 90° flat duct S vertical , Z861SIO : Adapter round-flat , Z861SI1 : 90° Adapter round-flat , Z861SM1 : Straight tube 500mm , Z861SM2 : Straight tube 1000mm , Z861SS1 : Connector sleeve (female) , Z861SS2 : Flex sleeve (female) , Z943SE0 : Set of 2 pots and 1 pan



4 242004 253112

*N 50, Induction hob with integrated ventilation  
system, 60 cm  
T46CB4AX2*

## Features

### Design

- Frameless
- 60 cm: space for 4 pots or pans.

### Flexibility of cooking zones

- Cooking zone front left: 210 mm, 2.2 KW (max. power 3.7 KW)
- Cooking zone rear left: 150 mm, 1.4 KW (max. power 2.2 KW)
- Cooking zone rear right: 150 mm, 1.4 KW (max power 2.2 KW)
- Cooking zone front right: 210 mm, 2.2 KW (max. power 3.7 KW)

### Usage convenience

- Touch control: control the power with imprinted +/- touch buttons.
- Variable 17-stage power settings for each zone: precisely adapt the heat with 17 power levels (9 main levels and 8 intermediate levels).
- Timer with automatic shut off for all zones  
: switches off the cooking zone at the end of the time set (e.g. for boiled eggs).
- LED timer for each zone with switch off function and acoustic signal  
: an alarm sounds at the end of the time set (e.g. for pasta).

### Time saving & efficiency

- Power Boost function for all zones  
: boil water faster thanks to 50% more energy than at the highest standard level.
- QuickStart function: when switching on, the hob automatically selects the cooking zone with cookware (when placed on a zone whilst the hob is off).
- ReStart function: in case of unintentional switch-off, this feature restores all previous settings by switching on the hob again within 4 seconds.
- Quick-Off: quickly switch off a cooking zone with one longer touch.

### Safety

- 2 stage residual heat indicators: indicates which cooking zones are still hot or warm.
- Control panel lock: prevent unintended activation of the hob.
- Control panel suspension: wipe overboiled liquids without unintentionally changing settings (blocking all touch buttons for 30 seconds).
- Main switch: switch off all cooking zones at the touch of a button.
- Safety cut out facility: for safety reasons, heating stops after a preset time if not used (possible to customise).

### Installation

- Dimensions of the product (HxWxD mm): 223 x 592 x 522
- Required niche size for installation (HxWxD mm) : 223 x 560 x (490 - 490)
- Min. worktop thickness: 16 mm
- Connected load: 7.4 KW
- 4.6kW power output (20A); current management options for 16A, 13A or 10A connection: limit the maximum power if needed (depends on fuse protection of electric installation).
- Power cord: 1.1 m, Cable included in packaging
- Suitable for installation into a 60 cm base cabinet

### Integrated ventilation downdraft system

- Induction cooktop with fully integrated high-performance downdraft extractor.
- Suitable for ducted or recirculated extraction configuration (incl. differentiated software modes). Installation accessories for unducted recirculation, among these four cleanAir odor filters and a telescopic slider element, are included in the cooktop. Accessories for other installation options are available, details in the planning notes.
- Aesthetically integrated fully flush air intake design with floating, heat resistant glass ceramics element for free movement and placement of cookware.
- Ventilation system with 3 electronically controlled fan power levels and 1 Boost-/Intensive fan power levels (with automatic revert) via Touch control user interface
- - Automatic switch-on of ventilation system when a cooking zone is used.
- - Automatic delayed shut-off after cooking to erase residual odors after cooking (in specific ultra low-noise fan level, 12min in ducted extraction, 30min in recirculated extraction, can be shut-off manually).
- - Fully manual control possible via Touch control.
- High-performance, low-noise blower with energy-efficient BLDC-technology. High extraction rates at very low noises with pleasant noise frequencies through psycho-acoustically and aerodynamically optimized interior with enclosed, non-visible blower. Highly pressuredrop resistant even with longer and more complex ductings.
- Easy-to-detach and easy-to-clean grease filter and liquid collector unit:
  - - Convenient one-hand removal of unit via floating glass ceramics handle.
  - - Integrated, large-scale, high performance stainless-steel grease filters with 12 filtration layers and one black top layer for

*N 50, Induction hob with integrated ventilation  
system, 60 cm  
T46CB4AX2*

**Features**

- enhanced aesthetical integration. Grease filtration efficiency of 94 %.
- - All parts of the unit are easy-to-clean, fully dishwasher safe and heat resistant.
- - (Upper) Liquid collector unit with 200ml of capacity for standard accidental spillages or cooking condensate.
- - Powerful drainage system for spillages that exceed 200ml of liquids.
- - Liquid safety collector with additional capacity of 700ml for more severe accidental situations. Dishwasher safe. Easily accessible and detachable from below.
- - Overall capturing capacity of 900ml (200ml + 700ml).
- - Watertight blower system.
- Ventilation system performance:
- - Extraction performance in ducted extraction (according to EN 61591): min. normal setting 330 m<sup>3</sup>/h , max. normal setting 500 m<sup>3</sup>/h , max. Boost-/Intensive setting 622 m<sup>3</sup>/h .
- - Extraction performance in recirculated extraction (according to EN 61591): min. normal setting 276 m<sup>3</sup>/h , max. normal setting 460 m<sup>3</sup>/h , max. Boost-/Intensive setting 600 m<sup>3</sup>/h.
- - Noise level in ducted extraction (Sound power level according to EN 60704-3): min. normal setting 61 dB re 1 pW, max. normal setting 69 dB re 1 pW, max. Boost-/Intensive setting 74 dB re 1 pW.
- - Noise level in recirculated extraction (Sound power level according to EN 60704-3. ): min. normal setting 56 dB re 1 pW, max. normal setting 68 dB re 1 pW, max. Boost-/Intensive setting 72 dB re 1 pW.
- - Grease filter efficiency (according to EN 61591) 94 %.
- Consumption data and energy efficiency (according to Regulation (EU) No 65/2014):
- - Energy Efficiency Class: B (at a range of energy efficiency classes from A+++ to D).
- - Fluid Dynamic Efficiency: A .
- - Average energy consumption: 57 .
- - Grease filtration efficiency class: B .
- - Noise min. normal setting & max. normal setting: 61 dB & 69 dB .
- For recirculation configuration: 2 x 2 battery of directly integrated, high-performance cleanAir odor filters.
- - Optimised odour reduction performance for cooking applications with complex odour molecules (e.g. fish).
- - Large scale filter surface with high odour reduction capabilities.
- - Lifetime of 360 hours of cooking (non-regenerative).
- - Low-noise filters with optimised psycho-acoustics.
- - Easy-to-access and easy-to-remove from above.
- - Replenishment cleanAir filter set Z821VR0.
- For ducted extraction configuration: 2 x 2 sets of directly integrated, high-performance low-noise acoustic filters for significantly lower noise and improved psycho-acoustics.

**Planning & installation notes**

- Suitable for ducted or recirculated extraction configuration in 4 different options (unducted, partly and fully ducted recirculation or ducted extraction). Installation accessories for unducted recirculation, among these four cleanAir odor filters and a telescopic slider element, are included in the cooktop. The included accessories allow easy and quick installations and can be planned in all worktop depths  $\geq 60$ cm. For other types of installation, one of the following accessory kits is recommended:
- Z861KR1 for partly-ducted recirculation in worktops of  $\geq 60$ cm depth with max. worktop height of 960 mm. Z861KR0 for partly-ducted recirculation in worktops of 70cm depth of  $\geq 70$ cm depth with max. worktop height of 960 mm.
- Z861KE1 as starter kit for ducted extraction in worktops of  $\geq 60$ cm depth.
- To complete the fully ducted extraction or to do any other individual recirculation planning different ducting accessories are available.
- Planning suggestions:
- - Installation is possible in island as well as wall oriented configurations.
- The product and its accessories comply with the Needle Flame Test (according to IEC 60695-11-5) and the V2 flammability class (according to UL94).
- - The max. immersion depth is 223 mm below worktop surface.
- - The appliance must be freely accessible from below (i.e. for accessing the lower liquid safety collector).
- - No false floor is necessary below the cooktop with integrated downdraft ventilation system. The drawers and/or shelves in the floor unit must be removable. The backpanel of the floor unit can be kept - only a cut-out for the air outlet is needed (position and size can be taken from the installation instructions).
- An installation with unducted recirculation requires a vertical aperture of min. 25mm behind the backpanel of the furniture. Suggested for ideal performance are 50mm.
- The minimum worktop thickness is 16 mm for top mounted and flush installed appliances with the standard installation system. Installation in even thinner worktops is also possible with the spare part: content 626792.
- - The overall appliance weight is 26kg - the bearing capacity and stability, in the case of very thin worktops in particular, must be supported using suitable substructures. The overall appliance weight and the worktop manufacturer's structural integrity specifications are to be taken into account.
- - For partly ducted and unducted recirculation extraction installations, a return-flow aperture of  $\geq 400$ cm<sup>2</sup> is to be respected in the plinth area. The aperture can be realized via outlet grids,

*N 50, Induction hob with integrated ventilation  
system, 60 cm  
T46CB4AX2*

#### Features

lamella grids or subtly shortened plinths depending on the assortment of the kitchen furniture manufacturer.

- - The air outlet on the backside of the appliance can directly be accessed with a male flat duct element (DN 150).
- - The pressuredrop resistant blower allows longer and more complex ductings up to 8m with three 90° bows while keeping sufficient performance.
- - When installing a ventilation hood with ducted extraction and a chimney-vented fireplace, the power supply line of the appliance needs a suitable safety switch. This is not required for configurations in recirculated extraction.
- - In ducted extraction configuration a one-way flap (or backflow trap) with a maximum opening pressure of 65Pa should be installed.

N 50, Induction hob with integrated ventilation system, 60 cm  
T46CB4AX2

Dimensioned drawings

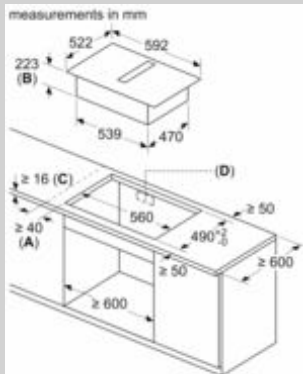

- A:** Minimum distance from the hob cut-out to the wall  
**B:** Recessing depth  
**C:** The worktop into which the hob is installed must withstand loads of approx. 60kg; suitable substructures must be used if required.

measurements in mm  
Front view - unit cut-out for unducted recirculation

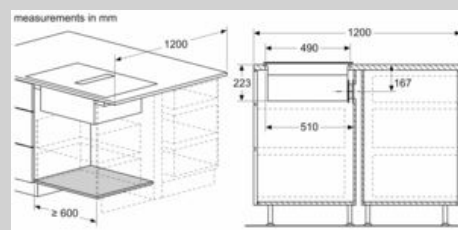
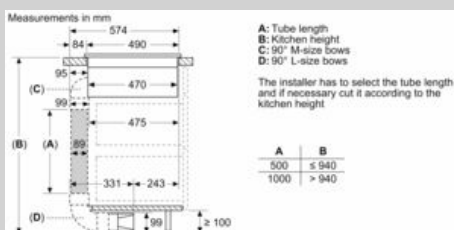
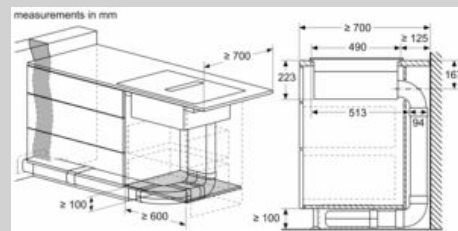
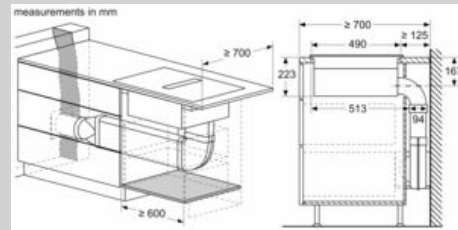
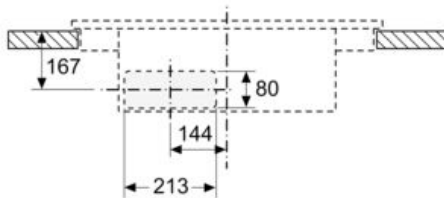

N 50, Induction hob with integrated ventilation system, 60 cm  
T46CB4AX2

## Dimensioned drawings

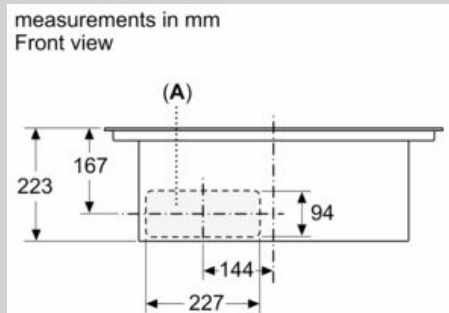
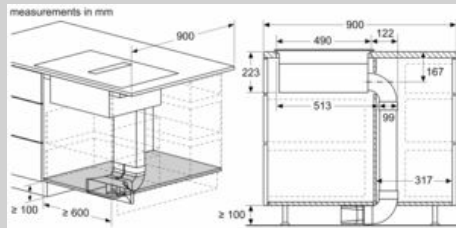

A: Connected directly at the rear

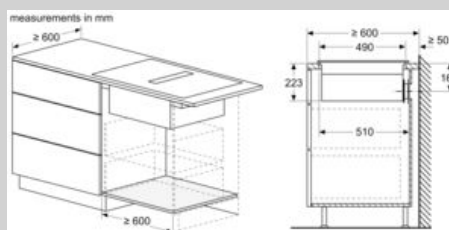
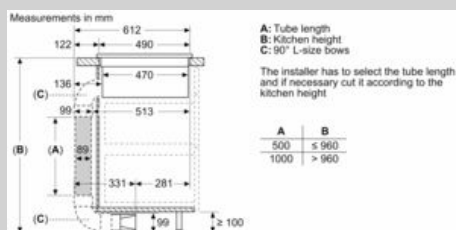
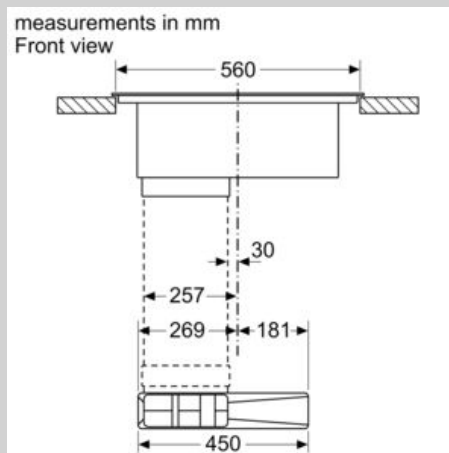
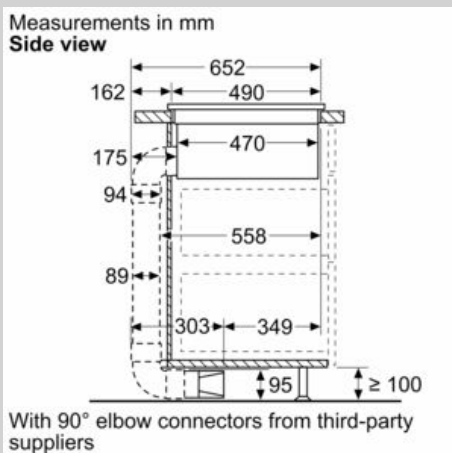

N 50, Induction hob with integrated ventilation  
system, 60 cm  
T46CB4AX2

Dimensioned drawings

