



Microwave Oven

[en] User manual and installation instructions

C17UR02.0B



Table of contents

USER MANUAL

1	Safety	2
2	Preventing material damage	5
3	Environmental protection and saving energy	6
4	Familiarising yourself with your appliance	7
5	Accessories	8
6	Before using for the first time	8
7	Basic operation	9
8	Microwave	9
9	Programmes	11
10	Timer	12
11	Basic settings	13
12	Cleaning and servicing	13
13	Troubleshooting	15
14	Disposal	16
15	Customer Service	16
16	How it works	17
17	INSTALLATION INSTRUCTIONS	21
17.1	Safe installation	22

1 Safety

Observe the following safety instructions.

1.1 General information

- Read this instruction manual carefully.
- Keep the instruction manual and the product information safe for future reference or for the next owner.
- Do not connect the appliance if it has been damaged in transit.

1.2 Intended use

Only a licensed professional may connect appliances without plugs. Damage caused by incorrect connection is not covered under the warranty.

The appliance can only be used safely if it is correctly installed according to the safety instructions. The installer is responsible for ensuring that the appliance works perfectly at its installation location.

Only use this appliance:

- To prepare meals and drinks.
- Under supervision. Never leave the appliance unattended when cooking for short periods.
- For household use and similar applications, such as: In kitchens for employees in shops, offices and other commercial sectors; in agriculture; by customers in hotels and other residential facilities; in bed and breakfasts.
- Up to an altitude of max. 4000 m above sea level.

This appliance complies with the standards EN 55011 and CISPR 11. It is a group 2, class B product. Group 2 means that microwaves are produced for the purpose of heating food. Class B means that the appliance is suitable for private households.

1.3 Restriction on user group

This appliance may be used by children aged 8 or over and by people who have reduced physical, sensory or mental abilities or inadequate experience and/or knowledge, provided that they are supervised or have been instructed on how to use the appliance safely and have understood the resulting dangers.

Children must not play with the appliance. Children must not perform cleaning or user maintenance unless they are at least 15 years old and are being supervised.

Keep children under the age of 8 years away from the appliance and power cable.

1.4 Safe use

Always place accessories in the cooking compartment the right way round.

→ "Accessories", Page 8

⚠ WARNING – Risk of fire!

Combustible objects that are left in the cooking compartment may catch fire.

- ▶ Never store combustible objects in the cooking compartment.
- ▶ If smoke is emitted, the appliance must be switched off or the plug must be pulled out and the door must be held closed in order to stifle any flames.

Loose food remnants, fat and meat juices may catch fire.

- ▶ Before using the appliance, remove the worst of the food residues and remnants from the cooking compartment, heating elements and accessories.

⚠ WARNING – Risk of burns!

Accessories and cookware get very hot.

- ▶ Always use oven gloves to remove accessories or cookware from the cooking compartment.

When the cooking compartment is hot, any alcoholic vapours inside may catch fire.

- ▶ Only use small quantities of drinks with a high alcohol content in food.
- ▶ Open the appliance door carefully.

⚠ WARNING – Risk of scalding!

The accessible parts of the appliance become hot during operation.

- ▶ Never touch these hot parts.
- ▶ Keep children at a safe distance.

Hot steam may escape when you open the appliance door. Steam may not be visible, depending on the temperature.

- ▶ Open the appliance door carefully.
- ▶ Keep children at a safe distance.

If there is water in the cooking compartment when it is hot, this may create hot steam.

- ▶ Never pour water into the cooking compartment when the cooking compartment is hot.

⚠ WARNING – Risk of injury!

Scratched glass in the appliance door may develop into a crack.

- ▶ Do not use any harsh or abrasive cleaners or sharp metal scrapers to clean the glass

on the appliance door, as they may scratch the surface.

The hinges on the appliance door move when the door is opened and closed, which could trap your fingers.

- ▶ Keep your hands away from the hinges.

⚠ WARNING – Risk of electric shock!

Incorrect repairs are dangerous.

- ▶ Repairs to the appliance should only be carried out by trained specialist staff.
- ▶ Only use genuine spare parts when repairing the appliance.
- ▶ If the power cord of this appliance is damaged, it must be replaced by the manufacturer, the manufacturer's Customer Service or a similarly qualified person in order to prevent any risk.

If the insulation of the power cord is damaged, this is dangerous.

- ▶ Never let the power cord come into contact with hot appliance parts or heat sources.
- ▶ Never let the power cord come into contact with sharp points or edges.
- ▶ Never kink, crush or modify the power cord.

An ingress of moisture can cause an electric shock.

- ▶ Do not use steam- or high-pressure cleaners to clean the appliance.

If the appliance or the power cord is damaged, this is dangerous.

- ▶ Never operate a damaged appliance.
- ▶ Never operate an appliance with a cracked or fractured surface.
- ▶ Never pull on the power cord to unplug the appliance. Always unplug the appliance at the mains.
- ▶ If the appliance or the power cord is damaged, immediately unplug the power cord or switch off the fuse in the fuse box.
- ▶ Call customer services. → Page 16

⚠ WARNING – Danger: Magnetism!

Permanent magnets are used in the control panel or in the controls. These may affect electronic implants, e.g. heart pacemakers or insulin pumps.

- ▶ Wearers of electronic implants must stay at least 10 cm away from the control panel.

⚠ WARNING – Risk of suffocation!

Children may put packaging material over their heads or wrap themselves up in it and suffocate.

- ▶ Keep packaging material away from children.
- ▶ Do not let children play with packaging material.

Children may breathe in or swallow small parts, causing them to suffocate.

- ▶ Keep small parts away from children.
- ▶ Do not let children play with small parts.

1.5 Microwave

CAREFULLY READ THE IMPORTANT SAFETY INSTRUCTIONS AND KEEP THEM SAFE FOR FUTURE USE

⚠ WARNING – Risk of fire!

Using the appliance for anything other than its intended purpose is dangerous and may cause damage. For example, heated slippers and pillows filled with grain or cereal may catch fire, even several hours later.

- ▶ Never dry food or clothing with the appliance.
- ▶ Never heat up slippers, pillows filled with grain or cereal, sponges, damp cleaning cloths or similar with the appliance.
- ▶ The appliance must only be used to prepare food and drink.

Food and its packaging and containers may catch fire.

- ▶ Never heat food in heat-retaining packaging.
- ▶ Do not leave food unattended while it is heating in containers made of plastic, paper or other combustible materials.
- ▶ Never set the microwave power too high or the cooking time too long. Follow the instructions provided in this user manual.
- ▶ Never use the microwave to dry food.
- ▶ Never defrost or heat food with a low water content, such as bread, at too high a microwave power or for too long.

Cooking oil may catch fire.

- ▶ Never use the microwave to heat cooking oil on its own.

⚠ WARNING – Risk of explosion!

Liquids and other food may easily explode when in containers that have been tightly sealed.

- ▶ Never heat liquids or other food in containers that have been tightly sealed.

⚠ WARNING – Risk of burns!

Foods with peel or skin may burst or explode during heating, or even afterwards.

- ▶ Never cook eggs in their shell or heat hard-boiled eggs in their shell.
- ▶ Never cook shellfish or crustaceans.
- ▶ Always prick the yolk of eggs before microwaving.
- ▶ The skin of foods that have a peel or skin, such as apples, tomatoes, potatoes and sausages, may burst. Before heating, prick the peel or skin.

Heat is not distributed evenly through baby food.

- ▶ Never heat baby food in closed containers.
- ▶ Always remove the lid or teat.
- ▶ Stir or shake well after heating.
- ▶ Check the temperature before giving the food or drink to a child.

Heated food gives off heat. The cookware may become hot.

- ▶ Always use oven gloves to remove cookware or accessories from the cooking compartment.

Airtight packaging may burst when food is heated.

- ▶ Always follow the instructions on the packaging.
- ▶ Always use oven gloves to remove the dishes from the cooking compartment.

The accessible parts of the appliance become hot during operation.

- ▶ Never touch these hot parts.
- ▶ Keep children at a safe distance.

Using the appliance for anything other than its intended purpose is dangerous. This is because, for instance, overheated slippers, pillows filled with grain or cereal, sponges and damp cleaning cloths, etc., may cause burns to the skin.

- ▶ Never dry food or clothing with the appliance.
- ▶ Never heat up slippers, pillows filled with grain or cereal, sponges, damp cleaning cloths or similar with the appliance.

- ▶ The appliance must only be used to prepare food and drink.

⚠ WARNING – Risk of scalding!

There is a possibility of delayed boiling when a liquid is heated. This means that the liquid reaches the boiling temperature without the usual steam bubbles rising to the surface. Exercise caution even when only gently shaking the container. The hot liquid may suddenly boil over and splatter.

- ▶ Always place a spoon in the container when heating liquids. This prevents delayed boiling.

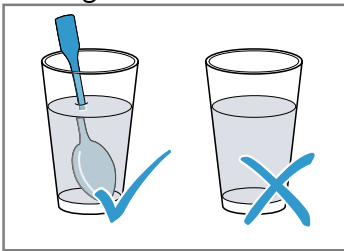

⚠ WARNING – Risk of injury!

Unsuitable cookware may crack. Porcelain or ceramic cookware can have small perforations in the handles and lid. These perforations conceal a cavity below. If moisture penetrates this cavity, it could cause the cookware to crack.

- ▶ Only use microwave-safe cookware. Cookware and containers made from metal or cookware with metal edging may lead to sparks being formed during simple mi-

crowave operation. The appliance is damaged.

- ▶ Never use metal containers during microwave-only operation.
- ▶ Only use microwave-safe cookware.

⚠ WARNING – Risk of electric shock!

The appliance uses a high voltage.

- ▶ Never remove the casing.

⚠ WARNING – Risk of serious harm to health!

Inadequate cleaning may destroy the surface of the appliance, reduce its service life, and lead to dangerous situations, such as escaping microwave energy.

- ▶ Clean the appliance on a regular basis, and remove any food residue immediately.
- ▶ Always keep the cooking compartment, door and door stop clean.

→ "Cleaning and servicing", Page 13

Never operate the appliance if the cooking compartment door is damaged. Microwave energy may escape.

- ▶ Never use the appliance if the cooking compartment door or the plastic door frame is damaged.
- ▶ Any repair work must only be carried out by the after-sales service.

Microwave energy will escape from appliances that do not have any casing.

- ▶ Never remove the casing.
- ▶ Contact our after-sales service if maintenance or repair work is needed.

2 Preventing material damage

2.1 General

ATTENTION!

The prolonged presence of moisture in the cooking compartment leads to corrosion.

- ▶ Always wipe away the condensation after cooking.
- ▶ Do not keep moist food in the cooking compartment for a long time with the door closed.
- ▶ Do not store food in the cooking compartment. Sitting or placing objects on the appliance door may damage it.
- ▶ Do not place, hang or support objects on the appliance door.

With certain models, accessories may scratch the door pane when closing the appliance door.

- ▶ Always push accessories fully into the cooking compartment.

2.2 Microwave

Follow these instructions when using the microwave.

ATTENTION!

Metal touching the wall of the cooking compartment will cause sparks, which may damage the appliance or the inner door pane.

- ▶ Metal (e.g. a spoon in a glass) must be kept at least 2 cm from the cooking compartment walls and the inside of the door.

Placing aluminium containers in the appliance may cause sparks, which will damage the appliance.

- ▶ Do not use aluminium containers in the appliance.

Operating the appliance without food in the cooking compartment may lead to overloading.

- ▶ Do not switch on the microwave unless there is food inside. The only exception to this rule is when performing a short cookware test.

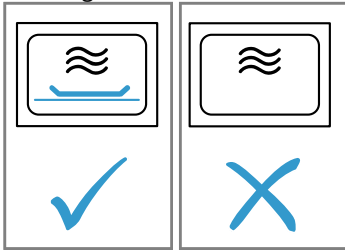

If you prepare several bags of microwave popcorn in immediate succession at a microwave power level that is too high, the cooking compartment may be damaged.

- ▶ Leave the appliance to cool down for several minutes between each use.
- ▶ Never set a microwave power level that is too high.
- ▶ Use a maximum microwave output of 600 watts.
- ▶ Always place the popcorn bag on a glass plate.

3 Environmental protection and saving energy

3.1 Disposing of packaging

The packaging materials are environmentally compatible and can be recycled.

- ▶ Sort the individual components by type and dispose of them separately.

3.2 Saving energy

If you follow these instructions, your appliance will use less power.

Hide the clock in standby mode.

- The appliance saves energy in standby mode.

4 Familiarising yourself with your appliance

4.1 Control panel

You can use the control panel to configure all functions of your appliance and to obtain information about the operating status.

On certain models, specific details such as colour and shape may differ from those pictured.

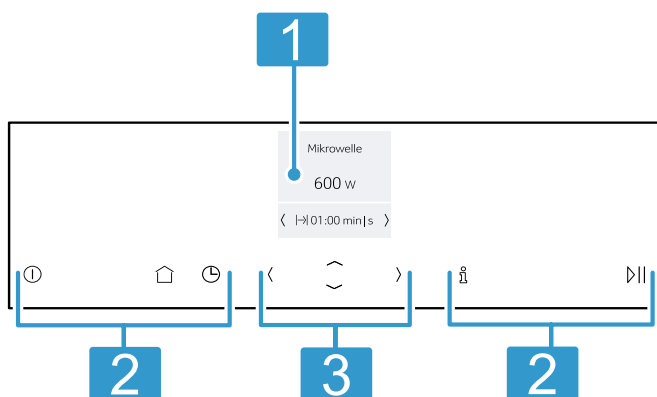

- | | |
|---|------------------------------|
| 1 | Display |
| 2 | Touch buttons |
| 3 | ShiftControl control element |

Touch buttons

Touch buttons are touch-sensitive buttons. To select a function, touch the relevant button.

Symbol	Touch button	Use
ⓘ	On/off	Switch the appliance on or off
🏠	Main menu	Select operating modes and settings
🕒	Time-setting options	Set the timer
ℹ️	Information	View additional information
▶	Start/stop	Start or pause operation

Note: When ℹ️ lights up, touch ℹ️ to display information for a few seconds.

ShiftControl control element

Use the ShiftControl control elements to navigate through the rows on the display and select settings. Settings that you can change have left and right arrows.

Symbol	Touch button	Use
<	Left	Navigate to the left on the display
>	Right	Navigate to the right on the display
^	Up	Navigate upwards on the display
~	Down	Navigate downwards on the display

Note: You can also press and hold the buttons to scroll through the adjustment values quickly. Release the button to stop the rapid scrolling.

Display

The display shows the current settings, options or relevant information.

Main menu

To access the main menu, press 🏠.

Symbol	Description
🔴	Microwave
🔴	Programmes
🔴	Easily prepare selected meals

Symbol	Description
	Settings Individually adjust the appliance settings

4.2 Cooking compartment

The functions in the cooking compartment make your appliance easier to use.

Interior lighting

When you open the appliance door, the interior lighting switches on. If the appliance door remains open for longer than approx. 5 minutes, the interior lighting switches off again.

With most types of heating and functions, the interior lighting remains on while the appliance is in operation. The interior lighting switches off again when the operation stops.

Cooling fan

The cooling fan switches on and off as required. The hot air escapes through the ventilation slots above the appliance door.

ATTENTION!

Covering the ventilation slots will cause the appliance to overheat.

- ▶ Do not cover the ventilation slots.

To cool the cooking compartment more quickly after operation, the cooling fan continues to run for a certain period afterwards. If the appliance is running in microwave operation, the appliance remains cool, but the cooling fan still switches on. The cooling fan may continue to run even when microwave operation has ended.

Condensation

Condensation can occur in the cooking compartment and on the appliance door when cooking. Condensation is normal and does not adversely affect appliance operation. Wipe away the condensation after cooking.

5 Accessories

Use original accessories. These have been made especially for your appliance.

Accessories	Use
Glass tray	<ul style="list-style-type: none"> ▪ For defrosting food ▪ For cooking food

6 Before using for the first time

Configure the settings for initial start-up. Clean the appliance and accessories.

6.1 Initial use

When the appliance is connected to the power supply for the first time or following a lengthy power failure, the settings for the initial start-up of your appliance appear.

Notes

- You can adjust the settings at any time in the basic settings.
→ "Basic settings", Page 13
- Open and close the appliance door for the internal inspection before the initial start-up or after any power failure.

Setting the language

1. Use \curvearrowright to navigate to the next line.
2. Use \langle or \rangle to select the language.
3. Use \curvearrowleft to navigate to the previous line.
4. Use \rangle to select the next setting.

Setting the time

1. Use \curvearrowright to navigate to the next line.
2. Use \langle or \rangle to select the current hour.

3. Use \curvearrowright to navigate to the next line.
4. Use \langle or \rangle to select the current minute.
5. Press \curvearrowleft repeatedly until "Time" appears.
6. Use \rangle to select the next setting.

Note:

In the → "Basic settings", Page 13, specify whether or not the display shows the time and date when the appliance is switched off.

Setting the date

1. Use \curvearrowright to navigate to the next line.
 2. Use \langle or \rangle to select the current day.
 3. Use \curvearrowright to navigate to the next line.
 4. Use \langle or \rangle to select the current month.
 5. Use \curvearrowright to navigate to the next line.
 6. Use \langle or \rangle to select the current year.
 7. Press \curvearrowleft repeatedly until "Date" appears.
 8. Use \rangle to implement the settings.
- ✓ The initial start-up is now complete.

6.2 Cleaning the accessories

- ▶ Clean the accessory thoroughly with soapy water and a soft dish cloth.

7 Basic operation

7.1 Switching on the appliance

- ▶ Press \odot to switch the appliance on.
- ✓ The display shows the Neff logo, followed by the maximum microwave output.
- ✓ The appliance is ready to use.

7.2 Switching off the appliance

- ▶ Press \odot to switch the appliance off.
- ✓ The appliance cancels the current functions.
- ✓ The time and date are shown on the display.

Note: Switch off your appliance when it is not being used. If no settings are applied for an extended period, the appliance switches itself off automatically.

7.3 Starting the operation

- ▶ Use $\triangleright||$ to start the operation.
- ✓ The display shows the settings.

Note: If you open the appliance door during operation, the appliance interrupts the operation and maintains the set time left. When you want to restart the operation, close the appliance door and press $\triangleright||$.

7.4 Interrupting the operation

1. Press $\triangleright||$.
- ✓ The appliance interrupts the operation.

2. Press \odot to delete all settings.

Note: When you open the appliance door, the appliance interrupts the operation. After an operation is interrupted or cancelled, the cooling fan may continue to run.

7.5 Setting the operating mode

When you switch on the appliance, the display shows the set default operating mode. You can start the suggested operating mode immediately or set a different operating mode.

1. Press $\hat{\square}$.
- ✓ The display shows the operating modes.
2. Use \langle or \rangle to select an operating mode.
3. Use \sim to navigate to the next line.
4. Use \langle or \rangle to select the setting.
Depending on the operating mode, additional settings are possible.
5. For each additional setting, use \sim to navigate to the next lines.
6. Use \langle or \rangle to select the setting.
7. Press $\triangleright||$.
- ✓ The appliance starts the operation.

Note: To exit the current setting and access the operating modes level, press $\hat{\square}$.

8 Microwave

You can use the microwave to cook, heat up or defrost food very quickly.

8.1 Microwave-safe cookware and accessories

To heat food evenly and avoid damaging your appliance, it is important to use the right cookware and accessories.

Note: Read the manufacturer's instructions before using any cookware in the microwave. If in doubt, carry out a cookware test.

Microwave-safe

Cookware and accessories	Reason
Cookware made from heat-resistant, microwave-safe material: <ul style="list-style-type: none"> ■ Glass ■ Glass ceramic ■ Porcelain ■ Temperature-resistant plastic ■ Fully glazed ceramic without cracks 	These materials allow microwaves to pass through. Microwaves do not damage heat-resistant cookware.
Metal cutlery	Note: You can use metal cutlery, e.g. place a spoon in a glass, to prevent delayed boiling.

ATTENTION!

Metal touching the wall of the cooking compartment will cause sparks, which may damage the appliance or the inner door pane.

- ▶ Metal (e.g. a spoon in a glass) must be kept at least 2 cm from the cooking compartment walls and the inside of the door.

Not microwave-safe

Cookware and accessories	Reason
Metal cookware	Metal does not allow microwaves to pass through. The food hardly heats up.
Cookware with gold or silver decoration	Microwaves can damage gold and silver decoration. Tip: You can only use this kind of cookware if the manufacturer guarantees that it is microwave-safe.

8.2 Testing cookware for microwave suitability

Test cookware to see whether it is suitable for microwave use. Testing cookware is the only time the appliance should be operated in microwave mode without any food inside.

WARNING – Risk of scalding!

The accessible parts of the appliance become hot during operation.

- ▶ Never touch these hot parts.
 - ▶ Keep children at a safe distance.
1. Place the empty cookware in the cooking compartment.
 2. Set the appliance to the maximum microwave power setting for 30 seconds to 1 minute.
 3. Start the operation.
 4. Check the cookware several times:
 - If the cookware is cold or warm to the touch, it is suitable for microwave use.
 - If the cookware becomes hot or sparks are created, stop the cookware test. The cookware is not microwave-safe.

8.3 Microwave power settings

Here you can find an overview of the different microwave power settings and when to use them.







Microwave output in watts	Maximum cooking time	Use
90 W	1:30 hours	Defrosting delicate foods.
180 W	1:30 hours	Defrosting food and continued cooking.
360 W	1:30 hours	Cooking meat and fish or heating delicate foods.
600 W	1:30 hours	Heating and cooking food.
900 W	30 minutes	Heating liquids. The maximum power setting is not designed for heating food.



Default settings

The appliance suggests a cooking time for each microwave power setting. You can accept this value or change it in the relevant area.



8.4 Configuring the microwave settings

When you switch the appliance on, the display always shows the highest microwave output as a suggestion.

1. Note the safety instructions. → *Page 4*
2. Observe the instructions on how to prevent material damage. → *Page 5*
3. Observe the information on microwave-safe cookware and accessories. → *Page 9*
4. Press .
 - ✓ The appliance is ready to use. The display shows the maximum microwave output as a default value. The microwave output can be changed at any time.
5. Use  or  to select a microwave output.
 - ✓ The display shows the microwave output and a default cooking time.
6. Press .
7. Use  or  to set the required cooking time.
8. Press .
 - ✓ The appliance starts the operation.



- ✓ The cooking time counts down on the display.
 - ✓ Once the cooking time has elapsed, a signal tone sounds.
9. Press  to end the signal tone early.
 10. Use  to switch the appliance off.

Notes

- If you press , the display shows the timer function for a short time. To hide the timer function immediately, press  again.
- If you open the appliance door in the meantime, the cooling fan may continue to run.



8.5 Changing the cooking time

You can change the cooking time at any time.

- ▶ Use  or  to change the cooking time.
- ✓ The operation continues.

8.6 Changing the microwave output setting

You can change the microwave output setting during operation.

1. Use  to change the microwave output.
2. Use  or  to set the required microwave output.
 - ✓ The cooking time remains unchanged.

- ✓ The operation continues.

9 Programmes

The programmes help you to use your appliance to prepare different dishes by selecting the optimum settings automatically.

9.1 Tips on configuring the settings for dishes

Follow these tips to achieve optimal cooking results.

- Only use food that is in perfect condition.
- Take the food out of its packaging and weigh it. If you cannot set the exact weight on the appliance, round the weight up or down.
- Only use microwave-safe, heat-resistant cookware, e.g. made of glass or ceramic.
- Place the food in the cold cooking compartment.

Defrost

- Freeze and store food flat and in portion-sized quantities at -18 °C.
- Place the frozen food on flat cookware, such as a glass or porcelain plate.
- Food may not be completely defrosted by the end of the programme. The food can nonetheless be further processed.
- Liquid is produced when defrosting meat or poultry. When turning, drain off any liquid. Do not use this for other purposes or allow it to come into contact with other foods.
- After turning, remove any minced meat that has already defrosted.
- Whole poultry should be placed on the cookware breast-side down and poultry portions skin-side down.

Vegetables

- Fresh vegetables: Cut into pieces of an equal size. Add one tablespoon of water per 100 g.
- Frozen vegetables: Only suitable for blanched, not pre-cooked vegetables. It is not suitable for frozen vegetables in cream sauce. Add 1 to 3 tablespoons of water. Do not add any water for spinach or red cabbage.

Potatoes

- Boiled potatoes: Cut into pieces of an equal size. Add two tablespoons of water and some salt per 100 g.
- Unpeeled boiled potatoes: Use potatoes of the same thickness. Wash them and prick the skin. Place the wet potatoes in a dish. Do not add water.

Note: If the set cooking time exceeds the maximum cooking time for the 900 W microwave output setting, the appliance automatically reduces the cooking time. The operation stops. Press \triangleright to start the operation.

- Baked potatoes: Use potatoes of the same thickness. Wash, dry and prick the skin.

Rice

- Do not use brown rice or boil-in-the-bag rice.
- Add two to two-and-a-half times the amount of water to the rice.

Resting time

Some dishes require a resting time in the cooking compartment after the programme has ended.

Dish	Resting time
Vegetables	Approx. 5 minutes
Potatoes	Approx. 5 minutes Drain the water first
Rice	Approx. 5-10 minutes

9.2 Setting a programme

1. Press \odot .
 - ✓ The appliance is ready to use.
2. Press \square .
 - ✓ The display shows the operating modes.
3. Use \langle or \rangle to select the $\text{P}\approx\text{Z}$ operating mode.
4. Press \sim .
 - ✓ The display shows the first programme.
5. Use \langle or \rangle to set the required programme.
6. Press \sim .
 - ✓ The display shows a default value for the weight.
7. Use \langle or \rangle to set the required weight.
8. Press \sim .
 - ✓ The display shows the preparation instructions.
9. Press \triangleright .
 - ✓ The appliance starts the operation.
 - ✓ The cooking time counts down on the display.
10. If the display provides instructions for turning or stirring during the programme:
 - Open the appliance door.
 - Break up, stir or turn the food.
 - Close the appliance door.
 - Press \triangleright .

Note: If you do not turn or stir the food, the programme continues as usual to the end. The programmes calculate the cooking time.

9.3 Programme table

You can prepare food very easily using the various programmes. You select a programme and enter the weight of your food. The programme then applies the most suitable settings.

Defrost

Dish	Suitable food	Weight range in kg	Cookware/accessories
Defrost bread ¹	Bread, whole, round or long; sliced bread; sponge cake, yeast cake, fruit flan, cakes without icing, cream or gelatine	0.10-0.55	Shallow cookware without lid Cooking compartment floor
Defrost meat ¹	Joints, flat pieces of meat, minced meat, chicken	0.10-0.55	Shallow cookware without lid Cooking compartment floor
Defrost fish ¹	Whole fish, fish fillet, fish steak	0.10-0.55	Shallow cookware without lid Cooking compartment floor

¹ Observe the signals given when it is time to turn the food.

Cooking

Dish	Suitable food	Weight range in kg	Cookware/accessories
Fresh vegetables ¹	Cauliflower, broccoli, carrots, kohlrabi, leeks, peppers, courgettes	0.10-0.55	Cookware with lid Cooking compartment floor
Frozen vegetables ¹	Cauliflower, broccoli, carrots, kohlrabi, red cabbage, spinach	0.10-0.55	Cookware with lid Cooking compartment floor
Boiled potatoes	Potatoes with or without skin, potatoes cut into pieces of an equal size	0.10-0.55	Cookware with lid Cooking compartment floor
Rice ¹	Long-grain rice	0.10-0.55	Deep cookware with lid Cooking compartment floor
Baked potatoes ¹	Potatoes with skin, approx. 6 cm thick	0.10-0.55	Wire rack Cooking compartment floor





¹ Observe the signals given when it is time to stir the food.

10 Timer

You can set the time on the timer. Once this time has elapsed, a signal tone sounds. You can set a maximum time on the timer of 24 hours.

The function works independently of the operation and other time-setting options. The timer signal is different from other signals.



10.1 Set the timer

- Press .
 - ✓ The display shows the timer.
 - Use  or  to set the timer duration.
 - Press .
- The timer also starts automatically after a few seconds.
- ✓ The timer counts down.
 - ✓ After a short time, the display switches back.
 - ✓ If an operating mode is running, the display also shows a timer symbol. When the appliance is switched off, the display shows the timer duration and a timer symbol.

- ✓ Once the timer duration has elapsed, a signal tone sounds.

- Press  to end the signal tone early.

10.2 Changing the timer

- Press .
- ✓ The display shows the timer.
- Use  or  to change the timer duration.

Note: The timer remains visible on the display if the appliance is switched off.

If an operating mode is running, you can use  to select the timer. The timer duration is highlighted for a short time. You can change the timer duration.













10.3 Cancelling the timer

- ▶ Reset the timer duration.
- ✓ Once this is implemented, the symbol no longer lights up.

11 Basic settings

You can configure the appliance to meet your needs.

11.1 Changing basic settings

1. Press .
2. Press .
3. Use  or  to select "Settings" .
4. Use  to navigate to the next line.
5. Use  or  to select the setting.
6. If required, use  to navigate to the next line.
7. Use  or  to select the setting.
8. Press .
9. Select "Save" to save the setting.

Note: Your changes to the basic settings will be retained even after a power failure.

11.2 Overview of the basic settings

This is where you can find an overview of the basic settings and factory settings. The basic settings depend on the features of your appliance.

Notes

- Changes to the language, button tone and display brightness settings take effect immediately. All other settings do not take effect until you save them.
- Your changes to the basic settings will be retained even after a power failure. Only the settings pertaining to the initial start-up of the appliance need to be implemented once again following a power failure. → "Initial use", Page 8

Basic settings	Selection
Language	Set "Language"
Time	Set "Time "
Date	Set "Date"













¹ Factory setting (may vary according to model)

Basic settings	Selection
Audible signal	Short cooking time Medium cooking time ¹ Long cooking time
Button tone	Switched off ¹ Switched on
Display brightness	The display brightness can be adjusted in 5 settings Setting 3 ¹
Clock display	Digital + date Digital Off ¹
Night-time dimming	Switched off ¹ Switched on (display dimmed between 10 p.m. and 6 a.m.)
Demo mode	Switched off ¹ Switched on (this is only displayed in the first 3 minutes following a reset or the initial start-up)
Factory settings	Reset Do not reset ¹

¹ Factory setting (may vary according to model)

Note: Changes to the language, button tone and display brightness settings take effect immediately. All other settings do not take effect until you save them.

11.3 Changing the time

1. Press .
2. Press .
3. Use  or  to select "Settings" .
4. Use  to navigate to the next line.
5. Use  or  to select "Time ".
6. If required, use  to navigate to the next line.
7. Use  or  to change the "Time ".
8. Press .
9. Select "Save" to save the setting.

12 Cleaning and servicing

To keep your appliance working efficiently for a long time, it is important to clean and maintain it carefully.

12.1 Cleaning products

Only use suitable cleaning agents.

WARNING – Risk of electric shock!

An ingress of moisture can cause an electric shock.

- ▶ Do not use steam- or high-pressure cleaners to clean the appliance.

ATTENTION!

Unsuitable cleaning agents damage the surfaces of the appliance.

- ▶ Do not use harsh or abrasive cleaning products.
- ▶ Do not use cleaning products with a high alcohol content.
- ▶ Do not use hard scouring pads or cleaning sponges.

- ▶ Do not use any special cleaners for cleaning the appliance while it is hot.
- ▶ Only use glass cleaners, glass scrapers or stainless steel care products if recommended in the cleaning instructions for the relevant part.

New sponge cloths contain residues from production.

- ▶ Wash new sponge cloths thoroughly before use.

You can find out which cleaning products are suitable for each surface or part of the appliance in the individual cleaning instructions.

12.2 Cleaning the appliance

Clean the appliance as specified. This will ensure that the different parts and surfaces of the appliance are not damaged by incorrect cleaning or unsuitable cleaning products.

⚠ WARNING – Risk of fire!

Loose food remnants, fat and meat juices may catch fire.

- ▶ Before using the appliance, remove the worst of the food residues and remnants from the cooking compartment, heating elements and accessories.

⚠ WARNING – Risk of injury!

Scratched glass in the appliance door may develop into a crack.

- ▶ Do not use any harsh or abrasive cleaners or sharp metal scrapers to clean the glass on the appliance door, as they may scratch the surface.

1. Read the information on cleaning products.
→ Page 13
2. Observe the information on cleaning the appliance components or surfaces.
3. Unless otherwise specified:
 - Clean the components of the appliance with hot soapy water and a dish cloth.
 - Dry with a soft cloth.

12.3 Cleaning the cooking compartment

ATTENTION!

Incorrect cleaning may damage the cooking compartment.

- ▶ Do not use oven spray, abrasive materials or other aggressive oven cleaners.

1. Read the information on cleaning products.
→ Page 13
2. Clean with hot soapy water or a vinegar solution.
3. Use oven cleaner to remove very heavy soiling. Only use oven cleaner when the cooking compartment is cold.
Tip: To eliminate unpleasant odours, heat up a cup of water with a few drops of lemon juice for 1 to 2 minutes at maximum microwave power setting. Always place a spoon in the container to prevent delayed boiling.
4. Wipe out the cooking compartment with a soft cloth.
5. Leave the cooking compartment to dry with the door open.

12.4 Cleaning the front of the appliance

ATTENTION!

Incorrect cleaning may damage the front of the appliance.

- ▶ Do not use glass cleaner, metal scrapers or glass scrapers for cleaning.
- ▶ To prevent corrosion on stainless steel fronts, remove any limescale, grease, starch and albumin (e.g. egg white) stains immediately.
- ▶ On stainless steel surfaces, use special stainless steel cleaning products suitable for hot surfaces.

1. Read the information on cleaning products.
→ Page 13

2. Clean the front of the appliance using hot soapy water and a dish cloth.

Note: Slight differences in colour on the front of the appliance are caused by the use of different materials, such as glass, plastic and metal.

3. For stainless steel appliance fronts, apply a thin layer of the stainless steel cleaning product with a soft cloth.
You can obtain the stainless steel cleaning products from the after-sales service or the online shop.
4. Dry with a soft cloth.

12.5 Cleaning the control panel

ATTENTION!

Incorrect cleaning may damage the control panel.

- ▶ Never wipe the control panel with a wet cloth.

1. Read the information on cleaning products.
→ Page 13
2. Clean the control panel using a microfibre cloth or a soft, damp cloth.
3. Dry with a soft cloth.

12.6 Cleaning the accessories

1. Read the information on cleaning products.
→ Page 13
2. Soften baked-on food remnants with a damp dish cloth and hot soapy water.
3. Clean the accessory with hot soapy water and a soft dish cloth or a scrubbing brush.
4. Dry with a soft cloth.

12.7 Cleaning the door panels

ATTENTION!

Incorrect cleaning may damage the door panes.

- ▶ Do not use a glass scraper.

1. Read the information on cleaning products.
→ Page 13
2. Clean the door panels with a soft dish cloth and glass cleaner.
Note: Shadows on the door panels, which look like streaks, are caused by reflections made by the interior lighting.
3. Dry with a soft cloth.

12.8 Cleaning the door seal

ATTENTION!

Incorrect cleaning may damage the door seal.

- ▶ Do not use metal scrapers or glass scrapers for cleaning.
- ▶ Do not use abrasive cleaning agents.

1. Read the information on cleaning products.
→ Page 13
2. Clean the door seal with hot soapy water and a soft dish cloth.
3. Dry with a soft cloth.

12.9 EasyClean

The cleaning aid is a quick alternative for occasionally cleaning the cooking compartment. The cleaning aid softens dirt by vaporising the soapy water. The dirt can then be removed more easily.

Setting the cleaning aid

1. Add a few drops of washing-up liquid to a cup of water.
2. Place a spoon in the cup to prevent delayed boiling.

3. Place the cup in the centre of the cooking compartment.
4. Set the microwave output to 600 W.
5. Set the cooking time to 5 minutes.
6. Start the microwave.
7. Once the cooking time has elapsed, leave the doors closed for an additional three minutes.
8. Wipe out the cooking compartment with a soft cloth.
9. Leave the cooking compartment to dry with the door open.

13 Troubleshooting

You can rectify minor faults on your appliance yourself. Read the troubleshooting information before contacting after-sales service. This will avoid unnecessary costs.

WARNING – Risk of injury!

Improper repairs are dangerous.

- ▶ Repairs to the appliance should only be carried out by trained specialist staff.
- ▶ If the appliance is defective, call Customer Service.

WARNING – Risk of electric shock!

Incorrect repairs are dangerous.

- ▶ Repairs to the appliance should only be carried out by trained specialist staff.
- ▶ Only use genuine spare parts when repairing the appliance.
- ▶ If the power cord of this appliance is damaged, it must be replaced by the manufacturer, the manufacturer's Customer Service or a similarly qualified person in order to prevent any risk.

13.1 Malfunctions

Fault	Cause and troubleshooting
The appliance is not working.	The mains plug of the power cord is not plugged in. ▶ Connect the appliance to the power supply.
	The circuit breaker in the fuse box has tripped. ▶ Check the circuit breaker in the fuse box.
	There has been a power cut. ▶ Check whether the lighting in your kitchen or other appliances are working.
	Malfunction <ol style="list-style-type: none"> 1. Switch off the fuse in the fuse box. 2. Switch the fuse back on after approx. 10 seconds. ✓ If the fault was a one-off, the message disappears. 3. If the message appears again, call the after-sales service. Please specify the exact error message when calling. → "Customer Service", Page 16
Appliance does not start.	Appliance door not fully closed. ▶ Close appliance door.
The appliance will not heat up; the  symbol is lit on the display	Demo mode is activated. <ol style="list-style-type: none"> 1. Disconnect the appliance from power supply by briefly switching off the circuit breaker in the fuse box. 2. Deactivate demo mode in the basic settings in the next 3 minutes.
The interior lighting is not working.	Interior lighting is defective ▶ Call the after-sales service. → "Customer Service", Page 16

13.2 Information on display panel

Fault	Cause and troubleshooting
The display shows the error message "Exxx"	<p>An error has occurred.</p> <ol style="list-style-type: none"> 1. If the display shows an error message, switch the appliance off and on again. ✓ If the display no longer shows the error message, it was a one-off problem. 2. If the display continues to show or repeatedly shows the error message, contact customer service and provide them with the error code. 3. If the display shows error message E0532, open and close the appliance door. 4. If the display shows error message E6501, switch the appliance off and then switch it back on again after 10 minutes.

14 Disposal

Find out here how to dispose of old appliances correctly.

14.1 Disposing of old appliance

Valuable raw materials can be reused by recycling.

1. Unplug the appliance from the mains.
2. Cut through the power cord.
3. Dispose of the appliance in an environmentally friendly manner.
Information about current disposal methods are available from your specialist dealer or local authority.



This appliance is labelled in accordance with European Directive 2012/19/EU concerning used electrical and electronic appliances (waste electrical and electronic equipment - WEEE).
The guideline determines the framework for the return and recycling of used appliances as applicable throughout the EU.

15 Customer Service

If you have any queries on use, are unable to rectify faults on the appliance yourself or if your appliance needs to be repaired, contact Customer Service. Detailed information on the warranty period and terms of warranty in your country is available from our after-sales service, your retailer or on our website. If you contact Customer Service, you will require the product number (E-Nr.) and the production number (FD) of your appliance. The contact details for Customer Service can be found in the enclosed Customer Service directory or on our website. This product contains light sources from energy efficiency class E. These light sources are available as a spare part and should only be replaced by trained specialist staff.

15.1 Product number (E-Nr.) and production number (FD)

You can find the product number (E-Nr.) and the production number (FD) on the appliance's rating plate. You will see the rating plate with these numbers if you open the appliance door. Make a note of your appliance's details and the Customer Service telephone number to find them again quickly.

16 How it works

Here, you can find the ideal settings for various dishes as well as the best accessories and cookware. We have tailored these recommendations to your appliance.

16.1 What is the best way to proceed?

In this section, you will find out the best way to proceed step-by-step in order to be able to make optimum use of the recommended settings. You will get information on many meals, with details and tips on how to best use and set your appliance.

Tip

Cooking tips

- The recommended settings always apply to the cooking compartment when it is cold and empty.
 - The times specified in the overviews are intended as a guide only. They will depend on the quality and composition of the food.
1. Before using the appliance, remove all unnecessary cookware from the cooking compartment.
 2. Select the desired food from the recommended settings.
 3. Place the food in suitable cookware.

4. Place the cookware in the middle on the cooking compartment floor.
The food will then absorb the microwaves from all sides.
5. Use the recommended settings when configuring the appliance settings.
Set the shorter cooking time first. If necessary, increase the cooking time.
6. Use an oven cloth or oven gloves when taking hot cookware out of the cooking compartment.

16.2 Defrosting, heating and cooking with the microwave

Recommended settings for defrosting, heating and cooking with the microwave.

The cooking time depends on the cookware, as well as on the temperature, composition and quantity of the food. This is why ranges are given in the tables. Begin with the lower value and, if necessary, use a higher setting the next time. It may be that you have different quantities from those specified in the tables. There is a rule of thumb for this: Double the amount = almost double the time, half the amount = half the time.

Defrosting with the microwave

Note:

Cooking tips

- Freeze the food flat.
- Use microwave-safe cookware without a lid.
- Place the cookware on the bottom of the cooking compartment.
- Turn or stir the food 2–3 times during this time. When turning, remove any liquid that escapes during defrosting.
- Liquid is produced when defrosting meat or poultry. When turning, drain off any liquid. Do not use this for other purposes or allow it to come into contact with other foods.
- After turning, remove any minced meat that has already defrosted.
- Separate any defrosted parts when turning.
- After defrosting, leave the food to rest for 10–60 minutes.

Food	Weight	Microwave output	Cooking time
Whole pieces of meat, on the bone or boned	800 g	1. 180 W 2. 90 W	1. 15 mins ¹ 2. 15-25 mins
Whole pieces of meat, on the bone or boned	1000 g	1. 180 W 2. 90 W	1. 20 mins ¹ 2. 20-30 mins ¹
Whole pieces of meat, on the bone or boned	1500 g	1. 180 W 2. 90 W	1. 25 mins ¹ 2. 25-30 mins ¹
Meat in pieces or slices	200 g	1. 180 W 2. 90 W	1. 5-8 mins ² 2. 5-10 mins
Meat in pieces or slices	500 g	1. 180 W 2. 90 W	1. 8-11 mins ² 2. 10-15 mins
Meat in pieces or slices	800 g	1. 180 W 2. 90 W	1. 10 mins ² 2. 10-15 mins
Minced meat, mixed	200 g	90 W	10-15 mins ¹

¹ Turn the food several times.

² Separate any defrosted parts when turning.

³ Carefully stir the food occasionally.

⁴ Remove all packaging.

⁵ Only defrost cakes without icing, whipped cream, gelatine or custard.

⁶ Separate the pieces of cake.

Food	Weight	Microwave output	Cooking time
Minced meat, mixed	500 g	1. 180 W 2. 90 W	1. 5 mins ¹ 2. 10-15 mins
Minced meat, mixed	1000 g	1. 180 W 2. 90 W	1. 15 mins ¹ 2. 10-15 mins
Poultry or poultry portions	600 g	1. 180 W 2. 90 W	1. 8 mins ¹ 2. 10-15 mins
Poultry or poultry portions	1200 g	1. 180 W 2. 90 W	1. 15 mins ¹ 2. 20-25 mins
Fish fillet, fish steak or fish slices	400 g	1. 180 W 2. 90 W	1. 5 mins 2. 10-15 mins
Whole fish	300 g	1. 180 W 2. 90 W	1. 3 mins ¹ 2. 10-15 mins
Whole fish	600 g	1. 180 W 2. 90 W	1. 8 mins ¹ 2. 15-20 mins
Vegetables, e.g. peas	300 g	180 W	10-15 mins ³
Fruit, e.g. raspberries	300 g	180 W	6-9 mins ³
Fruit, e.g. raspberries	500 g	1. 180 W 2. 90 W	1. 8 mins 2. 5-10 mins ³
Butter, defrosting ⁴	125 g	1. 180 W 2. 90 W	1. 1 mins ⁴ 2. 1-2 mins
Butter, defrosting ⁴	250 g	1. 180 W 2. 90 W	1. 1 mins 2. 2-4 mins
Loaf of bread	500 g	1. 180 W 2. 90 W	1. 8 mins ¹ 2. 5-10 mins
Loaf of bread	1000 g	1. 180 W 2. 90 W	1. 12 mins ¹ 2. 10-20 mins
Cakes, plain, e.g. sponge cake ^{5,6}	500 g	90 W	10-15 mins
Cakes, plain, e.g. sponge cake ^{5,6}	750 g	1. 180 W 2. 90 W	1. 5 mins 2. 10-15 mins
Cakes, moist, e.g. fruit flan, cheesecake ⁵	500 g	1. 180 W 2. 90 W	1. 5 mins 2. 15-20 mins
Cakes, moist, e.g. fruit flan, cheesecake ⁵	750 g	1. 180 W 2. 90 W	1. 7 mins 2. 15-20 mins

¹ Turn the food several times.

² Separate any defrosted parts when turning.

³ Carefully stir the food occasionally.

⁴ Remove all packaging.

⁵ Only defrost cakes without icing, whipped cream, gelatine or custard.

⁶ Separate the pieces of cake.

Tips on defrosting, heating and cooking with the microwave next time

Follow these tips for good results when defrosting, heating and cooking with the microwave.

Issue	Tip
Your food is too dry.	<ul style="list-style-type: none"> ■ Reduce the cooking time or select a lower microwave power setting. ■ Cover the food and add more liquid.

Issue	Tip
The time has elapsed but the food is not defrosted, hot or cooked.	Increase the cooking time. Large quantities and food which is piled high require longer times.
The time has elapsed but your food is not yet done on the inside, but is already overdone on the outside.	<ul style="list-style-type: none"> ■ Stir while cooking. ■ Reduce the microwave power setting and increase the cooking time.
After defrosting, the poultry or meat is defrosted on the outside but not defrosted in the middle.	<ul style="list-style-type: none"> ■ Reduce the microwave power setting. ■ Turn large pieces of frozen food several times.

16.3 Heating

With your appliance you can heat food.

Heating food in the microwave

Observe the recommended settings for using the microwave to heat food.

⚠ WARNING – Risk of scalding!

There is a possibility of delayed boiling when a liquid is heated. This means that the liquid reaches the boiling temperature without the usual steam bubbles rising to the surface. Exercise caution even when only gently shaking the container. The hot liquid may suddenly boil over and splatter.

- ▶ Always place a spoon in the container when heating liquids. This prevents delayed boiling.

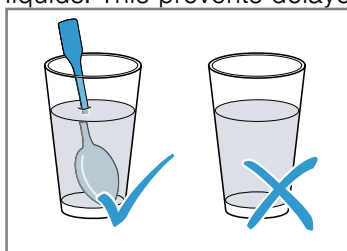

ATTENTION!

Metal touching the wall of the cooking compartment will cause sparks, which may damage the appliance or the inner door pane.

- ▶ Metal (e.g. a spoon in a glass) must be kept at least 2 cm from the cooking compartment walls and the inside of the door.

Note:

Cooking tips

- Use microwave-safe cookware with a lid. You can also use a plate or microwave film to cover the dish. Take ready meals out of the packaging.
- Place the cookware on the bottom of the cooking compartment.
- Turn or stir the food two or three times during the defrosting time.
- After defrosting, leave the food to rest for 2–5 minutes.
- The food transfers heat to the cookware. The cookware can become very hot. Use oven gloves.

Food	Weight	Microwave output	Cooking time
Menu, plated meal, ready meal (2-3 components)		600 W	5-8 mins
Beverages ¹	125 ml	900 W	0.5-1 min ^{2, 3}
Beverages ¹	200 ml	900 W	1-2 mins ^{2, 3}
Beverages ¹	500 ml	900 W	3-4 mins ^{2, 3}
Baby food, e.g. baby bottles ⁴	50 ml	360 W	Approx. 0.5 min ^{5, 6}
Baby food, e.g. baby bottles ⁴	100 ml	360 W	0.5-1 min ^{4, 6}
Baby food, e.g. baby bottles ⁴	200 ml	360 W	1-2 mins ^{4, 6}
Soup, 1 cup	175 g each	600 W	1-2 mins
Soup, 2 cups	175 g each	600 W	2-3 mins
Meat in sauce ⁷	500 g	600 W	7-10 mins
Stew	400 g	600 W	5-7 mins
Stew	800 g	600 W	7-8 mins
Vegetables, 1 portion	150 g	600 W	2-3 mins
Vegetables, 2 portions	300 g	600 W	3-5 mins

¹ Place a spoon in the glass.

² Do not overheat alcoholic drinks.

³ Check the food occasionally.

⁴ Heat up baby food without the teat or lid.

⁵ Always shake the food well after heating.

⁶ Always check the temperature.

⁷ Separate the slices of meat.

Heating frozen food in the microwave

Observe the recommended settings for using the microwave to heat food.

Note:

Cooking tips

- Use microwave-safe cookware with a lid. You can also use a plate or microwave film to cover the dish. Take ready meals out of the packaging.

- Distribute the food flat in the cookware. Food which lies flat cooks more quickly than food which is piled high.
- Place the cookware on the bottom of the cooking compartment.
- The food transfers heat to the cookware. The cookware can become very hot. Use oven gloves.
- Turn or stir the food two or three times during the defrosting time.
- After defrosting, leave the food to rest for 2–5 minutes.
- The food transfers heat to the cookware. The cookware can become very hot. Use oven gloves.
- The food will retain most of its natural flavor. Use salt and seasonings sparingly.

Food	Weight	Microwave output	Cooking time
Menu, plated meal, ready meal (2-3 components)	300-400 g	600 W	8-13 mins
Soup	400 g	600 W	8-12 mins
Stew	500 g	600 W	10-15 mins
Slices or pieces of meat in sauce, e.g. goulash	500 g	600 W	10-15 mins
Fish, e.g. fillet steaks	400 g	600 W	10-15 mins
Bakes, e.g. lasagne, cannelloni	450 g	600 W	10-15 mins
Side dishes, e.g. rice, pasta ¹	250 g	600 W	3-7 mins
Side dishes, e.g. rice, pasta ¹	500 g	600 W	8-12 mins
Vegetables, e.g. peas, broccoli, carrots ¹	300 g	600 W	7-11 mins
Vegetables, e.g. peas, broccoli, carrots ¹	600 g	600 W	14-17 mins
Creamed spinach ²	450 g	600 W	10-15 mins

¹ Add a little liquid to the food.

² Cook the food without any additional water.

16.4 Cooking

With your appliance you can cook food.

Cooking with the microwave

Note:

Cooking tips

- Place the cookware on the bottom of the cooking compartment.
- Distribute the food flat in the cookware. Food which lies flat cooks more quickly than food which is piled high.
- Use microwave-safe cookware with a lid. You can also use a plate or microwave film to cover the dish. Take ready meals out of the packaging.
- The food will retain most of its natural flavor. Use salt and seasonings sparingly.
- After defrosting, leave the food to rest for 2–5 minutes.
- The food transfers heat to the cookware. The cookware can become very hot. Use oven gloves.
- Even if the packaging specifies a higher output setting than 600 watts to cook the food, still use a maximum of 600 watts. If necessary, extend the specified cooking time until you achieve the desired result.

Food	Weight	Microwave output	Cooking time
Whole chicken, fresh, without giblets ¹	1200 g	600 W	25-30 mins
Fish fillet, fresh	400 g	600 W	7-12 mins
Fresh vegetables ^{2, 3, 4}	250 g	600 W	6-10 mins

¹ Turn the dish halfway through the cooking time.

² Cut into pieces of equal size.

³ Add a little water to the food.

⁴ Carefully stir the food occasionally.

⁵ Add double the amount of liquid.

⁶ Always place the popcorn bag on a glass plate. Follow the manufacturer's instructions.

Food	Weight	Microwave output	Cooking time
Fresh vegetables ^{2, 3, 4}	500 g	600 W	10-15 mins
Potatoes ^{2, 3, 4}	250 g	600 W	8-10 mins
Potatoes ^{2, 3, 4}	500 g	600 W	10-15 mins
Potatoes ^{2, 3, 4}	750 g	600 W	15-22 mins
Rice ⁵	125 g	1. 600 W 2. 180 W	1. 4-6 mins 2. 12-15 mins
Rice ⁵	250 g	1. 600 W 2. 180 W	1. 6-8 mins 2. 15-18 mins
Sweet foods, e.g. blanc-mange (instant) ⁴	500 ml	600 W	6-8 mins
Fruit, compote ⁴	500 ml	600 W	9-12 mins
Microwave popcorn ⁶	1 bag, 100 g	600 W	2.5-3.5 mins

¹ Turn the dish halfway through the cooking time.

² Cut into pieces of equal size.

³ Add a little water to the food.

⁴ Carefully stir the food occasionally.

⁵ Add double the amount of liquid.

⁶ Always place the popcorn bag on a glass plate. Follow the manufacturer's instructions.

16.5 Test dishes

These overviews have been produced for test institutes to facilitate appliance testing in accordance with EN 60350-1:2013 or IEC 60350-1:2011 and EN 60705:2012, IEC 60705:2010.

Cooking with the microwave

Food	Microwave power setting in W	Cooking time in mins	Note:
Custard, 1000 g	1. 600 W 2. 180 W	1. 11-12 mins 2. 8-10 mins	Pyrex dish
Sponge, 475 g	600 W	7-9 mins	Pyrex dish, 22 cm diameter
Meat loaf, 900 g	600 W	25-30 mins	Pyrex dish, 28 cm diameter, long

Defrosting with the microwave

Recommended settings for using the microwave to defrost food.

Food	Microwave power setting in W	Cooking time in mins	Note:
Meat, 500 g	1. 180 W 2. 90 W or the "Defrost meat" programme	1. 8 mins 2. 7-10 mins	Pyrex dish, 24 cm diameter

17 Installation instructions

Observe this information when installing the appliance.



17.1 Safe installation

Follow these safety instructions when installing the appliance.

- The appliance can only be used safely if it is correctly installed according to the safety instructions. The installer is responsible for ensuring that the appliance works perfectly at its installation location.
- Check the appliance for damage after unpacking it. Do not connect the appliance if it has been damaged in transit.
- Before starting up the appliance, remove any packaging material and adhesive film from the cooking compartment and the door.
- Proceed in accordance with the installation sheets for installing accessories.
- Fitted units must be temperature-resistant up to 90 °C, and adjacent unit fronts up to 65 °C.
- Do not install the appliance behind a decorative door or the door of a kitchen unit. There is a risk of overheating.
- Cut-out work on the units should be carried out before installing the appliance. Remove any shavings. Otherwise, the correct operation of electrical components may be adversely affected.
- Only a licensed professional may connect appliances without plugs. Damage caused by incorrect connection is not covered under the warranty.

WARNING – Risk of injury!

Parts that are accessible during installation may have sharp edges and may lead to cutting injuries.

- ▶ Wear protective gloves

WARNING – Risk of fire!

It is dangerous to use an extended power cord and non-approved adapters.

- ▶ Do not use extension cables or multiple socket strips.
- ▶ If the power cord is too short, contact Customer Service.
- ▶ Only use adapters approved by the manufacturer.

17.2 Appliance dimensions

You will find the dimensions of the appliance here

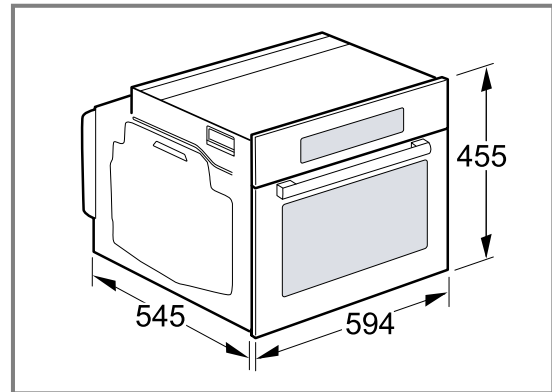

17.3 Fitted units

This appliance is only intended to be fully fitted in a kitchen. It is not intended to be used as a tabletop appliance or within a cupboard.

The fitted cabinet must not have a back panel behind the appliance. Maintain a clearance of at least 35 mm between the wall and the cabinet base or the rear panel of the cabinet situated above.

The fitted cabinet must have a ventilation opening of 50 cm² on the front. To do this, trim the base panel or fit a ventilation grille.

Surround units without a ventilation cut-out must have a ventilation opening measuring 200 cm² towards the rear of the side panels.

Ventilation slots and intake openings must not be covered.

The mains socket for the appliance must either be located in the hatched area  or outside of the area where the appliance is installed.

Any unsecured units must be secured to the wall using a standard bracket .

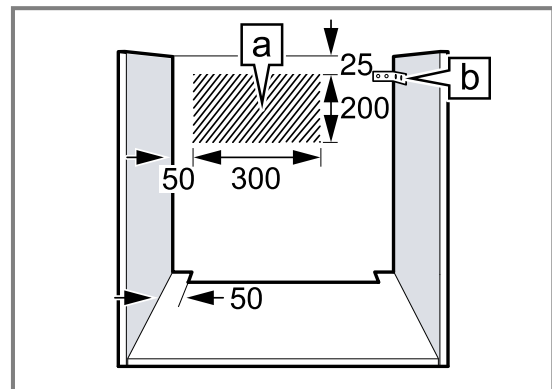

17.4 Electrical connection

In order to safely connect the appliance to the electrical system, follow these instructions.

WARNING – Danger: Magnetism!

The appliance contains permanent magnets. These may affect electronic implants, e.g. heart pacemakers or insulin pumps.

- ▶ Persons with electronic implants must stay at least 10 cm away from the appliance.

- The appliance corresponds to protection class I and must only be operated with a protective earth connection.
- The fuse protection must correspond to the power rating specified on the appliance's rating plate and to local regulations.
- The appliance must be disconnected from the power supply whenever installation work is being carried out.
- If the plug is no longer accessible following installation, an all-pole isolating switch with a contact distance of at least 3 mm must be present.
- The appliance must only be connected to a protective contact socket that has been correctly installed.
- Contact protection must be guaranteed by the installation.

17.5 Installation below a worktop

Observe the installation dimensions and the safety clearances when installing below a worktop. To ventilate the appliance, the intermediate floor must have a ventilation cut-out.

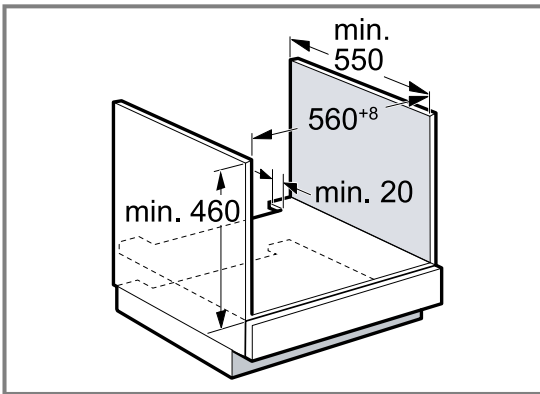

The worktop must be secured to the fitted unit.

17.6 Installing below a hob

If the appliance is installed below a hob, the following minimum dimensions must be adhered to (including substructure, if applicable).

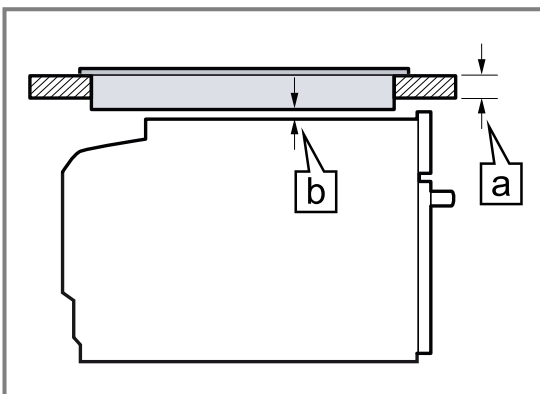

The minimum worktop thickness **b** is based on the required minimum clearance **a**.

Hob type	a raised in mm	a flush in mm	b in mm
Induction hob	48	49	5

Hob type	a raised in mm	a flush in mm	b in mm
Full-surface induction hob	58	59	5
Gas hob	38	49	5
Electric hob	38	41	2

Observe the installation instructions for the hob.

17.7 Installation in a tall unit

Observe the installation dimensions and the safety clearances in a tall unit. To ventilate the appliance, the intermediate floor must have a ventilation cut-out.

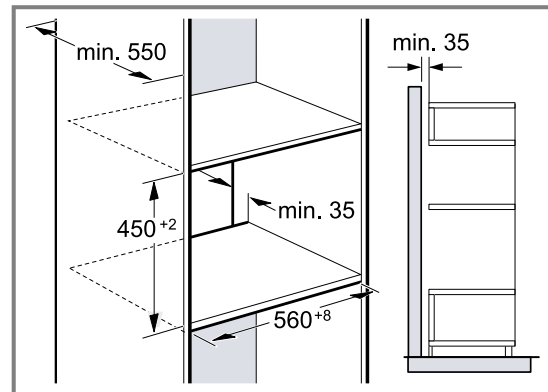

If the tall unit has another back panel in addition to the element back panels, this must be removed. Do not fit the appliance too high up; it must be possible for accessories to be removed easily.

17.8 Combination with a warming drawer

First fit the warming drawer. Follow the installation instructions for the warming drawer. Slide the appliance, on the warming drawer, into the fitted cabinet. When sliding in the appliance, do not damage the warming drawer's panel.

17.9 Corner installation

Observe the installation dimensions and the safety clearances when installing in a corner.

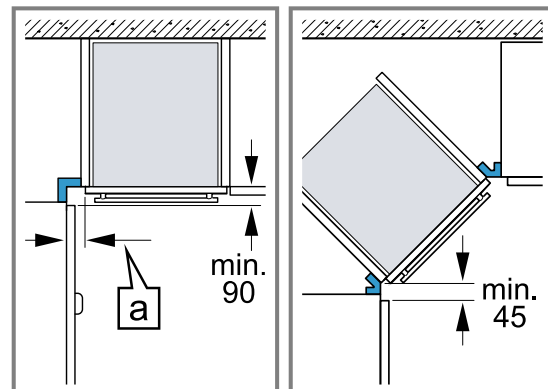

To ensure that the appliance door can be opened, you must take the minimum dimensions into consideration when installing in a corner. The dimension **a** is dependent on the thickness of the unit front and the handle.

17.10 Installing the appliance

ATTENTION!

Using a cordless screwdriver may damage the panels.

- ▶ Do not use a cordless screwdriver to secure the panels.

1. Push the appliance in fully.
Do not kink or trap the connection cable, or route it over sharp edges.
2. Centre the appliance.
3. Open the appliance door.
4. Unscrew the left- and right-hand panels.

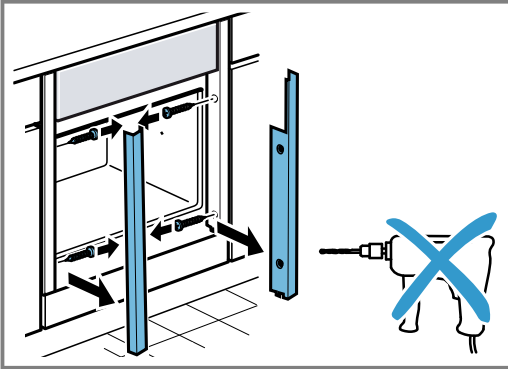

5. Screw the appliance tightly onto the unit.

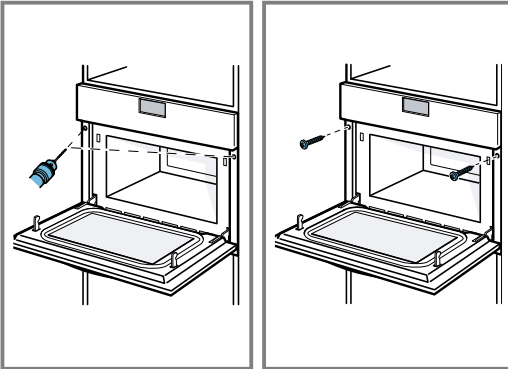

6. Refit the panels
7. Refit the panels and screw them in place, first at the top and then at the bottom.

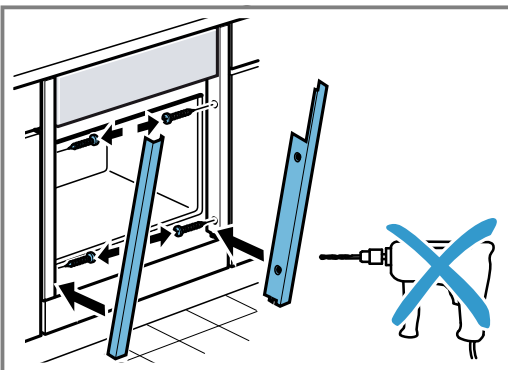

8. Remove any packaging material and adhesive film from the cooking compartment and the door.

Note:

The gap between the worktop and the appliance must not be closed by additional battens.

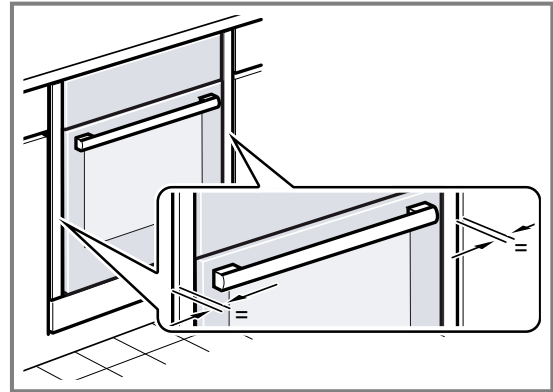

17.11 Removing the appliance

1. Disconnect the appliance from the power supply.
2. Open the appliance door.
3. Unscrew the left- and right-hand panels.
4. Undo the fastening screws.
5. Lift the appliance slightly and pull it out completely.



A series of horizontal lines for writing, starting from the top right of the pencil icon and extending across the width of the page. The lines are evenly spaced and cover the majority of the page area.



A series of horizontal lines for writing, starting from the top of the page and extending to the bottom. The lines are evenly spaced and cover the majority of the page's width.

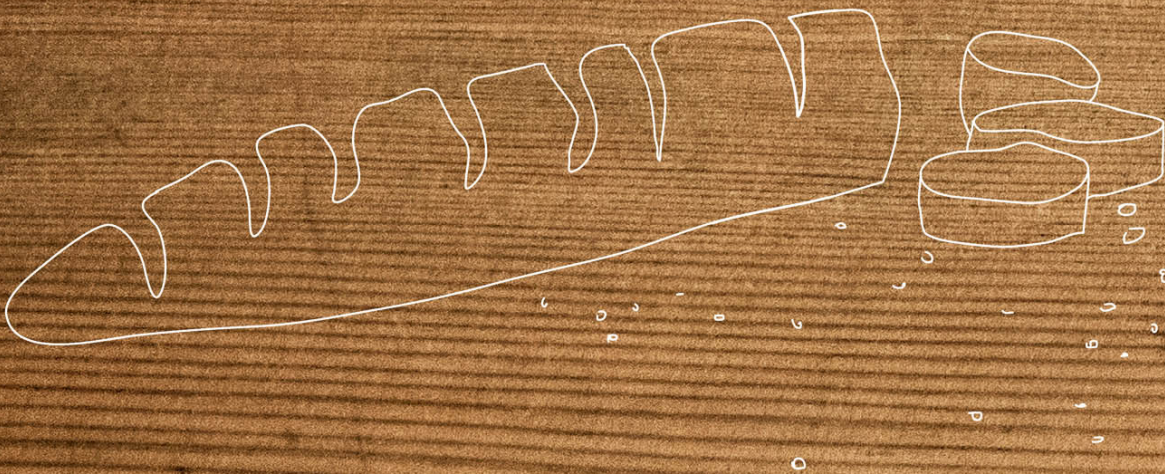

Valid within Great Britain:
Imported to Great Britain by
BSH Home Appliances Ltd.
Grand Union House
Old Wolverton Road
Wolverton, Milton Keynes
MK12 5PT
United Kingdom

REGISTER YOUR PRODUCT
ONLINE NEFF-HOME.COM

Constructa-Neff Vertriebs-GmbH
Carl-Wery-Straße 34
81739 München
GERMANY

9001654819
010713
en

