



Oven

[en] User manual and installation instructions

B5ACH7AH0B

# Table of contents

## USER MANUAL

1	<b>Safety</b> .....	2
2	<b>Preventing material damage</b> .....	4
3	<b>Environmental protection and saving energy</b> .....	5
4	<b>Familiarising yourself with your appliance</b> .....	6
5	<b>Accessories</b> .....	8
6	<b>Before using for the first time</b> .....	10
7	<b>Basic operation</b> .....	10
8	<b>Time-setting options</b> .....	11
9	<b>Childproof lock</b> .....	12
10	<b>Rapid heating</b> .....	12
11	<b>Sabbath mode</b> .....	13
12	<b>Basic settings</b> .....	13
13	<b>Home Connect</b> .....	14
14	<b>Cleaning and servicing</b> .....	16
15	<b>Cleaning functions</b> .....	18
16	<b>Shelf supports</b> .....	20
17	<b>Appliance door</b> .....	20
18	<b>Troubleshooting</b> .....	25
19	<b>Disposal</b> .....	27
20	<b>Customer Service</b> .....	27
21	<b>Declaration of Conformity</b> .....	27
22	<b>How it works</b> .....	28
23	<b>INSTALLATION INSTRUCTIONS</b> .....	31
23.1	<b>General installation instructions</b> .....	32

## 1 Safety

Observe the following safety instructions.

### 1.1 General information

- Read this instruction manual carefully.
- Keep the instruction manual and the product information safe for future reference or for the next owner.
- Do not connect the appliance if it has been damaged in transit.

### 1.2 Intended use

This appliance is designed only to be built into kitchen units. Read the special installation instructions.

Only a licensed professional may connect appliances without plugs. Damage caused by incorrect connection is not covered under the warranty.

Only use this appliance:

- To prepare meals and drinks.
- In private households and in enclosed spaces in a domestic environment.
- Up to an altitude of max. 4000 m above sea level.

### 1.3 Restriction on user group

This appliance may be used by children aged 8 or over and by people who have reduced physical, sensory or mental abilities or inadequate experience and/or knowledge, provided that they are supervised or have been instructed on how to use the appliance safely and have understood the resulting dangers.

Children must not play with the appliance.

Children must not perform cleaning or user maintenance unless they are at least 15 years old and are being supervised.

Keep children under the age of 8 years away from the appliance and power cable.

### 1.4 Safe use

Always place accessories in the cooking compartment the right way round.

→ "Accessories", Page 8

#### **WARNING – Risk of fire!**

Combustible objects that are left in the cooking compartment may catch fire.

- ▶ Never store combustible objects in the cooking compartment.
- ▶ If smoke is emitted, the appliance must be switched off or the plug must be pulled out and the door must be held closed in order to stifle any flames.

Loose food remnants, fat and meat juices may catch fire.

- ▶ Before using the appliance, remove the worst of the food residues and remnants from the cooking compartment, heating elements and accessories.

Opening the appliance door creates a draught. Greaseproof paper may come into contact with the heating element and catch fire.

- ▶ Never place greaseproof paper loosely over accessories when preheating the appliance and while cooking.
- ▶ Always cut greaseproof paper to size and use a plate or baking tin to hold it down.

### **⚠ WARNING – Risk of burns!**

The appliance and its parts that can be touched become hot during use.

- ▶ Caution should be exercised here in order to avoid touching heating elements.
- ▶ Young children under 8 years of age must be kept away from the appliance.

Accessories and cookware get very hot.

- ▶ Always use oven gloves to remove accessories or cookware from the cooking compartment.

When the cooking compartment is hot, any alcoholic vapours inside may catch fire.

- ▶ Only use small quantities of drinks with a high alcohol content in food.
- ▶ Open the appliance door carefully.

### **⚠ WARNING – Risk of scalding!**

The accessible parts of the appliance become hot during operation.

- ▶ Never touch these hot parts.
- ▶ Keep children at a safe distance.

Hot steam may escape when you open the appliance door. Steam may not be visible, depending on the temperature.

- ▶ Open the appliance door carefully.
- ▶ Keep children at a safe distance.

If there is water in the cooking compartment when it is hot, this may create hot steam.

- ▶ Never pour water into the cooking compartment when the cooking compartment is hot.

### **⚠ WARNING – Risk of injury!**

Scratched glass in the appliance door may develop into a crack.

- ▶ Do not use any harsh or abrasive cleaners or sharp metal scrapers to clean the glass on the oven door, as they may scratch the surface.

The hinges on the appliance door move when the door is opened and closed, which could trap your fingers.

- ▶ Keep your hands away from the hinges.

Components inside the appliance door may have sharp edges.

- ▶ Wear protective gloves.

### **⚠ WARNING – Risk of electric shock!**

Incorrect repairs are dangerous.

- ▶ Repairs to the appliance should only be carried out by trained specialist staff.
- ▶ Only use genuine spare parts when repairing the appliance.
- ▶ If the power cord of this appliance is damaged, it must be replaced by trained specialist staff.

If the insulation of the power cord is damaged, this is dangerous.

- ▶ Never let the power cord come into contact with hot appliance parts or heat sources.
- ▶ Never let the power cord come into contact with sharp points or edges.
- ▶ Never kink, crush or modify the power cord.

An ingress of moisture can cause an electric shock.

- ▶ Do not use steam- or high-pressure cleaners to clean the appliance.

If the appliance or the power cord is damaged, this is dangerous.

- ▶ Never operate a damaged appliance.
- ▶ Never pull on the power cord to unplug the appliance. Always unplug the appliance at the mains.
- ▶ If the appliance or the power cord is damaged, immediately unplug the power cord or switch off the fuse in the fuse box.
- ▶ Call customer services. → *Page 27*

### **⚠ WARNING – Danger: Magnetism!**

Permanent magnets are used in the control panel or in the controls. These may affect electronic implants, e.g. heart pacemakers or insulin pumps.

- ▶ Wearers of electronic implants must stay at least 10 cm away from the control panel.

### **⚠ WARNING – Risk of suffocation!**

Children may put packaging material over their heads or wrap themselves up in it and suffocate.

- ▶ Keep packaging material away from children.
- ▶ Do not let children play with packaging material.

Children may breathe in or swallow small parts, causing them to suffocate.

- ▶ Keep small parts away from children.
- ▶ Do not let children play with small parts.

### 1.5 Halogen bulb

#### **⚠ WARNING – Risk of burns!**

The bulbs in the cooking compartment get very hot. There is still a risk of burning for some time after they have been switched off.

- ▶ Do not touch the glass cover.
- ▶ Avoid contact with your skin when cleaning.

#### **⚠ WARNING – Risk of electric shock!**

When changing the bulb, the bulb socket contacts are live.

- ▶ Before replacing the bulb, ensure that the appliance is switched off in order to prevent a potential electric shock.
- ▶ Also unplug the appliance from the mains or switch off the circuit breaker in the fuse box.

### 1.6 Cleaning function

#### **⚠ WARNING – Risk of fire!**

Loose food remnants, fat and meat juices may catch fire when the cleaning function is in progress.

- ▶ Before you start the cleaning function, always remove coarse dirt from the cooking compartment.
- ▶ Never clean accessories at the same time.

The outside of the appliance gets very hot when the cleaning function is in progress.

- ▶ Never hang combustible objects, e.g. tea towels, on the door handle.
- ▶ Leave the front of the appliance clear.
- ▶ Keep children at a safe distance.

If the door seal is damaged, a large amount of heat is generated around the door.

- ▶ Do not scrub or remove the seal.
- ▶ Never operate the appliance if the seal is damaged or missing.

#### **⚠ WARNING – Risk of serious harm to health!**

The appliance gets very hot when the cleaning function is in progress. The non-stick coating on baking trays and tins is destroyed and noxious gases are released.

- ▶ Never clean non-stick baking trays or baking tins using the cleaning function.
- ▶ Never clean accessories at the same time.

#### **⚠ WARNING – Risk of harm to health!**

The cleaning function heats up the cooking compartment to a very high temperature so that food left over from roasting, grilling and baking will burn off. This process releases vapours, which can irritate mucous membranes.

- ▶ Keep the kitchen well ventilated while the cleaning function is running.
- ▶ Do not remain in the room for long periods.
- ▶ Keep children and pets away.

#### **⚠ WARNING – Risk of burns!**

The cooking compartment gets very hot when the cleaning function is in progress.

- ▶ Never open the appliance door.
- ▶ Allow the appliance to cool down.
- ▶ Keep children at a safe distance.

**⚠** The outside of the appliance gets very hot when the cleaning function is in progress.

- ▶ Never touch the appliance door.
- ▶ Allow the appliance to cool down.
- ▶ Keep children at a safe distance.

---

## 2 Preventing material damage

### 2.1 General

#### **ATTENTION!**

Objects on the cooking compartment floor at over 50 °C will cause heat to build up. The baking and roasting times will no longer be correct and the enamel will be damaged.

- ▶ Do not place any accessories, greaseproof paper or foil of any kind on the cooking compartment floor.
- ▶ Only place cookware on the cooking compartment floor if a temperature above 50 °C has been set.

When the cooking compartment is hot, any water inside it will create steam. The change in temperature may cause damage.

- ▶ Never pour water into the cooking compartment when it is still hot.
- ▶ Never place cookware containing water on the cooking compartment floor.

The prolonged presence of moisture in the cooking compartment leads to corrosion.

- ▶ Allow the cooking compartment to dry after use.
- ▶ Do not keep moist food in the cooking compartment for a long time with the door closed.
- ▶ Do not store food in the cooking compartment.

Leaving the appliance to cool down with the door open will damage the front of neighbouring kitchen units over time.

- ▶ Always allow the cooking compartment to cool down with the door closed after cooking at high temperatures.
- ▶ Take care not to trap anything in the appliance door.
- ▶ Only leave the cooking compartment to dry with the door open if a lot of moisture was produced during operation.

Fruit juice dripping from the baking tray leaves stains that cannot be removed.

- ▶ When baking very juicy fruit flans, do not pack too much on the baking tray.
- ▶ If possible, use the deeper universal pan.

Using oven cleaner in a hot cooking compartment damages the enamel.

- ▶ Never use oven cleaner in the cooking compartment when it is still warm.
- ▶ Remove all food remnants from the cooking compartment and the appliance door before you next heat up the appliance.

If the seal is very dirty, the appliance door will no longer close properly during operation. This may damage the front of adjacent kitchen units.

- ▶ Keep the seal clean at all times.
- ▶ Never operate the appliance if the seal is damaged or missing.

Sitting or placing objects on the appliance door may damage it.

- ▶ Do not place or hang objects on the appliance door.
- ▶ Do not place cookware or accessories on the appliance door.

With certain models, accessories may scratch the door pane when closing the appliance door.

- ▶ Always push accessories fully into the cooking compartment.

---

## 3 Environmental protection and saving energy

### 3.1 Disposing of packaging

The packaging materials are environmentally compatible and can be recycled.

- ▶ Sort the individual components by type and dispose of them separately.

### 3.2 Saving energy

If you follow these instructions, your appliance will use less power.

Only preheat the appliance if the recipe or the recommended settings tell you to do so.

- Not preheating the appliance can reduce the energy used by up to 20%.

Use dark-coloured, black-coated or enamelled baking tins.

- These types of baking tin absorb the heat particularly well.

Open the appliance door as little as possible during operation.

- This will maintain the temperature in the cooking compartment and eliminate the need for the appliance to reheat.

When baking multiple dishes, do so in succession or in parallel.

- The cooking compartment is heated after baking the first dish. This reduces the baking time for the second cake.

If the cooking time is relatively long, you can switch the appliance off 10 minutes before the cooking time ends.

- There will be enough residual heat to finish cooking the dish.

Remove any accessories that are not being used from the cooking compartment.

- Accessories that are not being used do not need to be heated.

Allow frozen food to defrost before cooking.

- This will save the energy that would otherwise be required to defrost it.

## 4 Familiarising yourself with your appliance

### 4.1 Controls

You can use the control panel to configure all functions of your appliance and to obtain information about the operating status.

On certain models, specific details such as colour and shape may differ from those pictured.

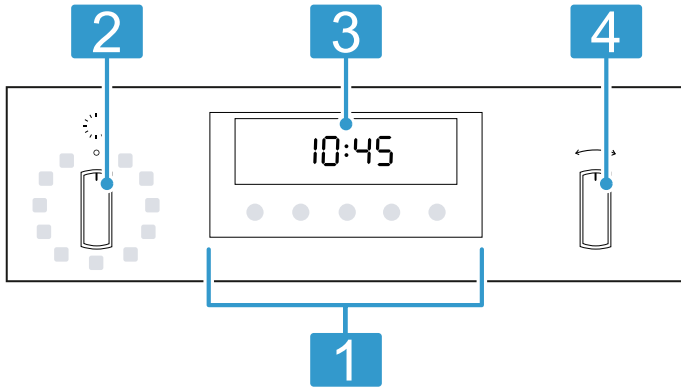

#### 1 Buttons

→ "Buttons", Page 6

#### 2 Function selector

You can turn the function selector clockwise or anti-clockwise from the zero setting.

→ "Types of heating", Page 7 → "Functions", Page 7

#### 3 Display

→ "Display", Page 6

#### 4 Temperature selector

Use the temperature selector to set the temperature for the type of heating or select the setting for other functions. You can turn the temperature selector clockwise and anti-clockwise.

→ "Temperature and setting levels", Page 8

**Note:** Depending on the appliance type, the control knobs can be pushed in. To click it in or out, push the control knob in when it is in the off position.

### 4.2 Buttons

The buttons are touch-sensitive surfaces. Press the corresponding button to select a function.



Symbol	Name	Use
⌚	Time-setting options	Sets the time, timer, cooking time or end time → "Time-setting options", Page 11
<	Left arrow	Decreases the adjustment values
>	Right arrow	Increases the adjustment values
⏩	Rapid heating	Starts or cancels rapid heating → "Rapid heating", Page 12
ℹ	Information	<ul style="list-style-type: none"> <li>Displays the current cooking compartment temperature</li> <li>Set basic settings → "Basic settings", Page 13</li> </ul>

### 4.3 Display

The display shows the current settings, options or relevant information.









The red bar above or below a symbol indicates which value is active or can be changed.

Symbol	Name	Use
H	Temperature too high	The temperature in the cooking compartment is too high for the operating mode; leave the appliance to cool down → "Residual heat", Page 8
Sabb	Sabbath mode	Sabbath mode activated → "Sabbath mode", Page 13
🔒	Childproof lock activated	The childproof lock is activated → "Childproof lock", Page 12

Symbol	Name	Use
	Door lock	Appliance door is locked → "Childproof lock", Page 12  → "Pyrolytic self-cleaning ", Page 18
	Temperature display	Appliance is heating → "Temperature display", Page 8

## 4.4 Types of heating





Here you can find an overview of the types of heating. You can find recommendations on using the types of heating. Use the function selector to set the types of heating.

Symbol	Type of heating and temperature range	What it's used for/how it works
	CircoTherm hot air 30 - 200 °C	Bake and roast on one or more levels. The fan distributes the heat from the ring-shaped heating element in the back wall evenly around the cooking compartment.
	CircoTherm gentle 125 - 200 °C	Cook selected dishes gently on one level without preheating. The fan distributes the heat from the ring-shaped heating element in the back wall evenly around the cooking compartment. The food is cooked in phases using residual heat. Always keep the appliance door closed when cooking. This type of heating is used to determine the energy consumption in air recirculation mode and the energy efficiency class.
	Bread baking setting 180 - 240 °C	For baking bread, bread rolls and baked goods that require high temperatures.
	Pizza setting 30 - 275 °C	Cook pizza or dishes that require a lot of heat from below. The bottom heating element and the ring-shaped heating element in the back wall heat the cooking compartment.
	Bottom heating 30 - 250 °C	Final baking or cooking food in a bain marie. Heat is emitted from below.
	Full-surface grill 30 - 275 °C From 275 °C: 	Grill flat items such as steak and sausages, or make toast. Gratinated food. The entire area underneath the grill element becomes hot.
	Circo-roasting 30 - 250 °C	Roast poultry, whole fish and larger pieces of meat. The grill element and the fan switch on and off alternately. The fan circulates the hot air around the food.
	Top/bottom heating 30 - 275 °C	Traditionally bake or roast on one level. This type of heating is ideal for cakes with moist toppings. The heat is emitted evenly from above and below. This type of heating is used to measure the energy consumption in the conventional mode.

## 4.5 Functions

Here you can find an overview of the functions. Use the function selector to set the functions.

**Note:** If you operate your appliance with the Home Connect app, even more functions are available for you. You can find more information about this in the app.

Symbol	Name	Use
	Oven light	Illuminate the cooking compartment without heating. → "Lighting", Page 8
	Remote start	Start and operate the appliance via the Home Connect app. → Page 14
	Cleaning functions	<ul style="list-style-type: none"> <li>▪ EasyClean  removes light dirt from the cooking compartment. → "Cleaning aid EasyClean ", Page 19</li> <li>▪ Pyrolytic self-cleaning  cleans the cooking compartment almost by itself. → "Pyrolytic self-cleaning ", Page 18</li> </ul>

## 4.6 Temperature and setting levels

There are different settings for the types of heating and functions.

The settings appear in the display.

The temperature can be set in 1 degree increments up to 100 °C, and in 5 degree increments thereafter.

**Note:** For temperature settings above 275 °C for the Grill type of heating, the appliance reduces the temperature to approx. 250 °C after approx. 20 minutes.

### Temperature display

The temperature display shows you the temperature in the cooking compartment.

#### Notes

- The temperature indicator only shows the temperature increasing for operating modes for which you can set a temperature, e.g. for cleaning functions, the temperature display is filled immediately.
- Due to thermal inertia, the temperature displayed may differ slightly from the actual temperature inside the cooking compartment.

As soon as the appliance heats up, the  $\delta$  symbol appears in the display.

The lines  $\square$  are filled from the bottom to the top as the cooking compartment heats up.

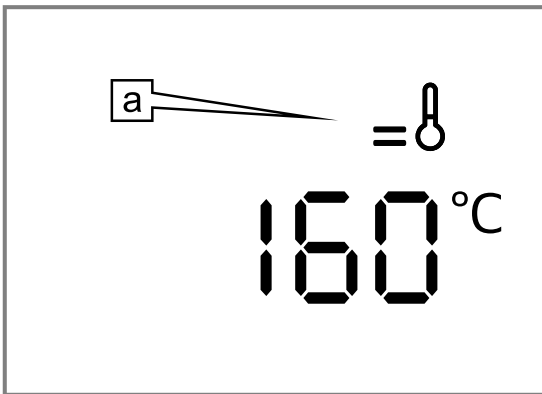

When you are preheating the appliance, the optimal time to place your food in the cooking compartment is when the  $\delta$  symbol first goes out.

### Residual heat

When the appliance is switched off, the temperature indicator shows the residual heat in the cooking compartment.

The further the temperature drops, the more lines go out.

If **H** flashes in the display, the temperature in the cooking compartment is too high for the selected operating mode. Switch the appliance off, wait until it has cooled down and then switch it back on again.

## 4.7 Cooking compartment

The functions in the cooking compartment make your appliance easier to use.

### Rails

The rails in the cooking compartment enable you to place accessories at different heights.

→ "Accessories", Page 8

Your appliance has four shelf positions. The shelf positions are numbered from bottom to top.

You can remove the rails, e. g. for cleaning.

→ "Shelf supports", Page 20

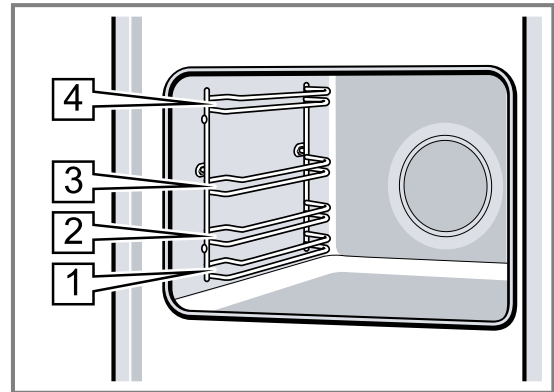

### Lighting

The oven light lights up the cooking compartment. With most types of heating and functions, the lighting lights up during operation. When the function selector is turned to bring operation to an end, the lighting goes out.

The **Oven light** setting on the function selector can be used to switch on the light without heating.

### Cooling fan

The cooling fan switches on and off depending on the appliance's temperature. The hot air escapes above the door.

#### ATTENTION!

Do not cover the ventilation slot above the appliance door. The appliance overheats.

- Ensure that the ventilation slots are unobstructed.

To ensure that the appliance cools down more quickly after operation, the cooling fan continues to run for a certain period afterwards.

### Appliance door

If you open the appliance door during operation, the operation continues.

## 5 Accessories

Use original accessories. These have been made especially for your appliance.

**Note:** Accessories may become deformed if they get hot. Deformation has no effect on function. As the accessory cools down, it will regain its original shape.

The accessories supplied may differ depending on the appliance model.



Accessories	Use
Wire rack	<ul style="list-style-type: none"> <li>■ Cake tins</li> <li>■ Ovenproof dishes</li> <li>■ Cookware</li> <li>■ Meat, e.g. roasting joints or steak</li> <li>■ Frozen meals</li> </ul>
Universal pan	<ul style="list-style-type: none"> <li>■ Moist cakes</li> <li>■ Baked items</li> <li>■ Bread</li> <li>■ Large roasts</li> <li>■ Frozen meals</li> <li>■ Catching dripping liquids, e.g. fat when grilling food on the wire rack.</li> </ul>

## 5.1 Locking function

The locking function prevents the accessories from tilting when they are pulled out.

You can pull out the accessories approximately halfway without them tipping. The accessories must be inserted into the cooking compartment correctly for the tilt protection to work properly.

## 5.2 Sliding accessories into the cooking compartment

Always slide accessories into the cooking compartment correctly. This is the only way to ensure that accessories can be pulled out approximately halfway without tipping.

1. Turn the accessories so that the notch  is at the rear and is facing downwards.
2. Insert accessories between the two guide rods for the shelf position.

3. Push the accessory all the way in, making sure that it does not touch the appliance door.

**Note:** Take any accessories that you will not be using out of the cooking compartment while the appliance is in operation.

### Combining accessories

You can combine the wire rack with the universal pan to catch any liquid that drips down.

1. Place the wire rack on the universal pan so that both spacers  are on the rear edge of the universal pan.
2. Insert the universal pan between the two guide rods for a shelf position. In so doing, the wire rack is on top of the upper guide rod.

Wire rack on universal pan

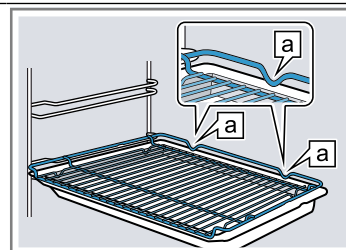

## 5.3 Other accessories

You can purchase other accessories from our after-sales service, specialist retailers or online.

You will find a comprehensive range of products for your appliance in our brochures and online: [www.neff-international.com](http://www.neff-international.com)

Accessories vary from one appliance to another. When purchasing accessories, always quote the exact product number (E no.) of your appliance.

You can find out which accessories are available for your appliance in our online shop or from our after-sales service.

Wire rack Insert the wire rack with the open side facing the appliance door and the curved lip  facing downwards.

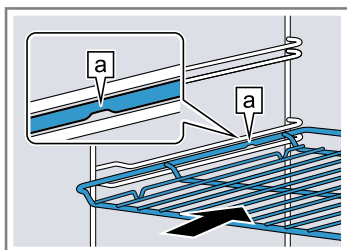

Baking tray E.g. universal pan or baking tray Slide the tray, e.g. the universal pan, in with the sloping edge  facing the appliance door.

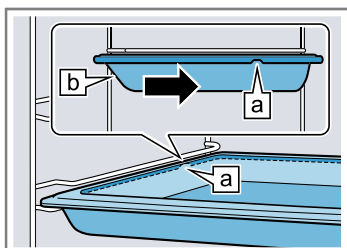

## 6 Before using for the first time

Configure the settings for initial start-up. Clean the appliance and accessories.

### 6.1 Initial use

You need to make settings for initial use before you can use your appliance.

#### Setting the time on the clock

Once the appliance has been connected to the mains or following a power failure, the time flashes on the display. The time starts at "12:00". Set the current time.

**Requirement:** The function selector must be set to the "Off" position  $\circ$ .

1. Use the < or > button to set the time.
  2. Press the  $\ominus$  button.
- ✓ The time that is set appears on the display.

**Tip:** You can go to the basic settings → Page 13 to specify whether or not the time should be shown on the display.

### 6.2 Cleaning the appliance before using it for the first time

Clean the cooking compartment and accessories before using the appliance to prepare food for the first time.

1. Remove any accessories and leftover packaging, such as polystyrene pellets, from the cooking compartment.
2. Before heating the appliance, wipe the smooth surfaces in the cooking compartment with a soft, damp cloth.
3. Keep the room ventilated while the appliance is heating.
4. Set the type of heating and temperature.  
→ "Basic operation", Page 10

---

Type of heating	CircoTherm hot air $\mathcal{A}$
-----------------	----------------------------------

---

Temperature	Maximum
-------------	---------

---

Cooking time	1 hour
--------------	--------

---

5. Switch off the appliance after the specified cooking time.
6. Wait until the cooking compartment has cooled down.
7. Clean the smooth surfaces with soapy water and a dish cloth.
8. Clean the accessories using soapy water and a dish cloth or soft brush.

## 7 Basic operation

### 7.1 Switching on the appliance

- ▶ Turn the function selector to any position other than the "Off" position  $\circ$ .
- ✓ The appliance is switched on.

### 7.2 Switching off the appliance

- ▶ Turn the function selector to the "Off" position  $\circ$ .
- ✓ The appliance is switched off.

### 7.3 Setting the type of heating and temperature

1. Use the function selector to set the type of heating.
  2. Use the temperature selector to set the temperature or grill setting.
- ✓ The appliance starts heating after a few seconds.
- ✓ Depending on the appliance type, rapid heating  $\mathcal{A}$  automatically switches off for set temperatures of 200 °C and above for certain types of heating.  
→ "Rapid heating", Page 12

3. When your food is ready, switch off the appliance.

#### Tips

- The most suitable type of heating for your food can be found in the description of the type of heating.  
→ "Types of heating", Page 7
- You can also set a cooking time and end time on the appliance.  
→ "Time-setting options", Page 11

#### Changing the type of heating

You can change the type of heating at any time.

- ▶ Use the function selector to set the required type of heating.

#### Changing the temperature

You can change the temperature at any time.

- ▶ Use the temperature selector to set the required temperature.

## 8 Time-setting options

Your appliance has different time-setting options, with which you can control its operation.

### 8.1 Overview of the time-setting options

With the  $\odot$  button, select the different time-setting options.

Time-setting option	Use
Timer $\Delta$	The timer can be set independently of the appliance when it is in operation. It does not affect the appliance.
Cooking time $\text{I}\rightarrow\text{I}$	If you set a cooking time, operation of the appliance stops automatically once this time has elapsed.
End time $\rightarrow\text{I}$	For the cooking time, you can set the time at which operation ends. The appliance starts up automatically so that it finishes cooking at the required time.
Time $\odot$	You can set the time.

### 8.2 Setting the timer

The timer runs independently of the appliance when it is in operation. The timer can be set when the appliance is switched on or off, up to 23 hours and 59 minutes. The timer has its own audible signal so that you can tell whether it is the timer or a cooking time which has elapsed.

1. Press the  $\odot$  button repeatedly until  $\Delta$  is highlighted in the display.
2. Use the  $\langle$  or  $\rangle$  button to set the timer duration.

Button	Default value
$\langle$	5 minutes
$\rangle$	10 minutes

The timer duration can be set in 30-second increments up to 10 minutes. Above 10 minutes, the time increments become longer the higher the value.

- ✓ The timer starts and the timer duration begins to count down after a few seconds.
  - ✓ An audible signal sounds and the timer duration is zero in the display when the timer duration has elapsed.
3. Once the timer duration has elapsed:
    - Press any button to switch off the timer.

#### Changing the timer

You can change the timer duration at any time.

**Requirement:**  $\Delta$  is highlighted on the display.

- ▶ Use the  $\langle$  or  $\rangle$  button to change the timer duration.
- ✓ The appliance applies the change after a few seconds.

#### Cancelling the timer

You can cancel the timer duration at any time.

**Requirement:**  $\Delta$  is highlighted on the display.

- ▶ Use the  $\langle$  button to reset the timer duration to zero.
- ✓ After a few seconds, the appliance applies the change and  $\Delta$  goes out.

### 8.3 Setting the cooking time

You can set a cooking time for operation of up to 23 hours 59 minutes.

**Requirement:** The type of heating and temperature or setting are set.

1. Press the  $\odot$  button repeatedly until  $\text{I}\rightarrow\text{I}$  is highlighted in the display.
2. Use the  $\langle$  or  $\rangle$  button to set the cooking time.

Button	Default value
$\langle$	10 minutes
$\rangle$	30 minutes

The cooking time can be set in 1-minute increments up to 1 hour, and then in 5-minute increments.

- ✓ The appliance starts heating and the cooking time counts down after a few seconds.
  - ✓ If the cooking time has elapsed, an audible signal sounds and the display shows the cooking time as zero.
3. When the cooking time has elapsed:
    - Press any button to end the audible signal before it sounds.
    - To set a cooking time again, press the  $\rangle$  button.
    - When your food is ready, switch off the appliance.

#### Changing the cooking time

You can change the cooking time at any time.

**Requirement:**  $\text{I}\rightarrow\text{I}$  is highlighted on the display.

- ▶ Change the cooking time using the  $\langle$  or  $\rangle$  button.
- ✓ The appliance applies the change after a few seconds.

#### Cancelling the cooking time

You can cancel the cooking time at any time.

**Requirement:**  $\text{I}\rightarrow\text{I}$  is highlighted on the display.

- ▶ Reset the cooking time to zero using the  $\langle$  button.
- ✓ After a few seconds, the appliance applies the change and continues to heat without a cooking time.

### 8.4 Setting the end time







You can delay the time at which cooking is due to finish by up to 23 hours and 59 minutes.

#### Notes

- In order to achieve a good cooking result, do not delay the end time once the appliance is already in operation.
- Food will spoil if you leave it in the oven cavity too long.

#### Requirements



- The type of heating and temperature or setting are set.
- A cooking time is set.

1. Press the  button repeatedly until  is highlighted in the display.
2. Press the  or  button.
  - ✓ The display shows the calculated end time.
3. Use the  or  button to delay the end time.
  - ✓ After a few seconds, the appliance applies the setting and the display shows the set end time.
  - ✓ Once the calculated start time has been reached, the appliance starts heating up and the cooking time starts counting down.
  - ✓ Once the time has elapsed, an audible signal sounds and the display shows the cooking time as zero.
4. When the cooking time has elapsed:
  - Press any button to end the signal prematurely.
  - To set another cooking time, press the  button.
  - When your food is ready, switch off the appliance.

### Changing the end time

In order to achieve a good cooking result, you can only change the set end time before operation starts and the cooking time starts counting down.

**Requirement:**  is highlighted on the display.

- ▶ Use the  or  button to delay the end time.
- ✓ The appliance applies the change after a few seconds.

### Cancelling the end time

You can delete the set end at any time.



**Requirement:**  is highlighted on the display.

- ▶ Reset the end time to the current time plus the set cooking time using the  button.
- ✓ After a few seconds, the appliance applies the change and starts heating up. The cooking time counts down.

## 8.5 Setting the time on the clock

Once the appliance has been connected to the mains or following a power failure, the time flashes on the display. The time starts at "12:00". Set the current time.

**Requirement:** The function selector must be set to the "Off" position .





1. Use the  or  button to set the time.
2. Press the  button.
  - ✓ The time that is set appears on the display.

**Tip:** You can go to the basic settings → *Page 13* to specify whether or not the time should be shown on the display.

### Changing the time on the clock

You can change the time on the clock at any time.

**Requirement:** The function selector must be set to the "Off" position .

1. Press the  button repeatedly until  is highlighted in the display.
2. Use the  or  button to change the time.
  - ✓ The appliance applies the change after a few seconds.

---

## 9 Childproof lock

You can secure your appliance to prevent children from accidentally switching it on or changing the settings.

**Note:** You can go to the basic settings → *Page 13* to specify whether you want the option to set the childproof lock.

You can only use the childproof lock to lock the control elements of the appliance. In addition, you can lock the appliance door.

→ *"Basic settings", Page 13*

### 9.1 Automatic childproof lock

When the appliance is switched off, it locks automatically. You need to pause the automatic childproof lock before you switch on the appliance.



You can activate and deactivate the automatic childproof lock in the basic settings.

→ *"Basic settings", Page 13*

### Pausing the automatic childproof lock

**Requirement:** The automatic childproof lock is activated in the basic settings.



→ *"Basic settings", Page 13*

- ▶ Press and hold the  button until  goes out on the display.



### 9.2 Childproof lock

If you activate the childproof lock, the appliance is locked until you deactivate the childproof lock. If you switch off the appliance after the next operation, the childproof lock is not activated automatically.

#### Activating the childproof lock

- ▶ Press and hold the  button until  appears on the display.

#### Deactivating the childproof lock

- ▶ Press and hold the  button until  goes out on the display.

---

## 10 Rapid heating

To save time, rapid heating can shorten the preheating time for set temperatures over 100 °C.

Rapid heating is possible for the following types of heating:

- **CircoTherm hot air** 





- **Bread baking setting** 
- **Top/bottom heating** 

## 10.1 Setting rapid heating



To ensure an even cooking result, do not place the food in the cooking compartment until rapid heating has come to an end.

**Note:** Do not set a cooking time until rapid heating has come to an end.

1. Set a suitable type of heating and a temperature of at least 100 °C.  
Rapid heating automatically switches off at temperatures of 200 °C and above.

2. If rapid heating does not switch off automatically, press the  button.
  - ✓  appears in the display and the  arrows are filled from the bottom to the top.
  - ✓ Rapid heating starts after a few seconds.
  - ✓ Once rapid heating has ended, a signal tone sounds and the  symbol goes out on the display.
3. Place the food in the cooking compartment.

### Cancelling rapid heating

- ▶ Press the  button.
- ✓ The  symbol disappears from the display.

## 11 Sabbath mode

You can set a time of over 70 hours using Sabbath mode. You can use **Top/bottom heating** to keep food warm between 85 °C and 140 °C during this time without having to switch the appliance on or off.





### 11.1 Starting Sabbath mode

#### Notes

- If you open the appliance door during operation, the appliance stops heating. When you close the appliance door, the appliance continues to heat again.
- Once it has started, you can no longer change or interrupt Sabbath mode.
- You cannot delay the end time for Sabbath mode.

**Requirement:** Sabbath mode is activated in the basic settings.

→ "Basic settings", Page 13





















1. Use the function selector to set the type of heating .
  - ✓  appears in the display.
2. Use the temperature selector to set the temperature.
3. Use the  or  button to set the time.
- ✓ After a few seconds, the appliance starts heating and the cooking time counts down.
4. Once the time has elapsed, the display shows the time as zero. The appliance stops heating up and responds again as usual outside of Sabbath mode.
  - Switch off the appliance.
 The appliance automatically switches off after approx. 10 to 20 minutes.

## 12 Basic settings

You can configure the appliance to meet your needs.

### 12.1 Overview of the basic settings

Here you can find an overview of the basic settings and factory settings. The basic settings depend on the features of your appliance.

Display	Basic setting	Selection
	Automatic childproof lock	 = no <sup>1</sup>  = yes
	Signal duration upon completion of a cooking time or timer period	 = 10 seconds  = 30 seconds <sup>1</sup>  = 2 minutes
	Waiting time until a setting is adopted	 = 3 seconds <sup>1</sup>  = 6 seconds  = 10 seconds
	Button tone when pressing a button	 = off  = on <sup>1</sup>
	Brightness of the display illumination	 = dark  = medium <sup>1</sup>  = bright
	Time display	 = hide the time  = display the time <sup>1</sup>

<sup>1</sup> Factory setting (may vary according to model)

<sup>2</sup> Depending on the appliance specifications

Display	Basic setting	Selection
☐06	Childproof lock can be adjusted	☐ = no   = yes <sup>1</sup> ☒ = yes, with locked door
☐07	Interior lighting during operation	☐ = no   = yes <sup>1</sup>
☐08	Cooling fan run-on time	= short ☒ = medium <sup>1</sup> 3 = long 4 = extra long
☐09	Telescopic shelves retrofitted <sup>2</sup>	☐ = no <sup>1</sup> (for rails and 1-level pull-out)   = yes (for 2- and 3-level pull-out)
☐10	Sabbath mode available	☐ = no <sup>1</sup>   = yes
☐12	Automatic rapid heating from 200 °C <sup>2</sup>	☐ = no   = yes <sup>1</sup>
☐13	Reset all values to factory settings	☐ = no <sup>1</sup>   = yes
HC..	Home Connect Settings	→ "Home Connect ", Page 14

<sup>1</sup> Factory setting (may vary according to model)

<sup>2</sup> Depending on the appliance specifications

## 12.2 Changing basic settings

**Requirement:** The appliance is switched off.

1. Press and hold the  button for approximately four seconds.
  - ✓ The first basic setting appears in the display, e.g. ☐00 |.
2. Use the temperature selector to change the setting.
3. Use the < or > button to switch to the next basic setting.

4. To save the changes, press and hold the  button for approx. four seconds.

**Note:** Your changes to the basic settings will be retained even after a power failure.

## 12.3 Discarding changes to the basic settings

- ▶ Turn the function selector.
- ✓ All changes are discarded and not saved.

# 13 Home Connect

This appliance is network-capable. Connecting your appliance to a mobile device lets you control its functions via the Home Connect app, adjust its basic settings and monitor its operating status.

The Home Connect services are not available in every country. The availability of the Home Connect function depends on the availability of Home Connect services in your country. You can find information about this at: [www.home-connect.com](http://www.home-connect.com).

The Home Connect app guides you through the entire login process. Follow the instructions in the Home Connect app to configure the settings.

### Tips

- Please consult the documents supplied by Home Connect.
- Please also follow the instructions in the Home Connect app.

### Notes

- Please note the safety precautions in this instruction manual and make sure that they are also observed when operating the appliance via the Home Connect app.

→ "Safety", Page 2

- Operating the appliance on the appliance itself always takes priority. During this time it is not possible to operate the appliance using the Home Connect app.
- In networked standby mode, the appliance requires a maximum of 2 W.

## 13.1 Setting up Home Connect

### Requirements

- The appliance is connected to the power supply and is switched on.
- You have a mobile device with a current version of the iOS or Android operating system, e.g. a smartphone.
- The mobile device and the appliance are within range of your home network's Wi-Fi signal.

1. Download the Home Connect app.



- Open the Home Connect app and scan the following QR code.



- Follow the instructions in the Home Connect app.

## 13.2 Home Connect Settings

You can adjust the settings and network settings for Home Connect in the basic settings for your appliance.

Setting	Selection or display	Explanation
HC 01	Connection to the network 0 – Not connected 1 – Connect automatically 2 – Connect manually 3 – Connected	0 and 3 are displays that you cannot set.
HC 02	Connection to the Home Connect app 0 – Ready 1 – Connect 2 – Connected	0 and 2 are displays that you cannot set.
HC 03	Wi-Fi 0 – Off 1 – Activate 2 – On	If Wi-Fi is activated, you can use Home Connect. In networked standby mode, the appliance requires a maximum of 2 W. 2 is a display that you cannot set.
HC 04	Remote start 0 – Deactivated 1 – Manual <sup>1</sup> 2 – Permanent	When remote start is deactivated, you can only view the operating status of the appliance in the app. For manual remote start, you must activate the remote start each time before you can start the appliance via the app. If you open the appliance door within 15 minutes of activating remote start or of the operation ending, remote start is deactivated. For permanent remote start, you can start and operate the appliance remotely at any time.
HC 05	Software update 1 – Update available 2 – Start update	The setting is only displayed if an update is available. 1 is a display that you cannot set.
HC 06	Remote Diagnostics 0 – Not authorised <sup>1</sup> 1 – Authorised	The setting is only displayed if after-sales service is attempting to access the appliance.

<sup>1</sup> Factory setting

## 13.3 Operating the appliance with the Home Connect app

You can use the Home Connect app to set and start the appliance remotely.

### **⚠ WARNING – Risk of fire!**

Combustible objects that are left in the cooking compartment may catch fire.

- ▶ Never store combustible objects in the cooking compartment.
- ▶ If smoke is emitted, the appliance must be switched off or the plug must be pulled out and the door must be held closed in order to stifle any flames.

### **Requirements**

- The appliance is switched on.
  - The appliance is connected to your home network and to the Home Connect app.
  - In order to be able to set the appliance via the app, the manual or permanent remote start must be selected in the HC 04 basic setting.
1. To activate the remote start, set the function selector to 0.
  2. Implement a setting in the app and send it to the appliance.

## 13.4 Software update

Your appliance's software can be updated using the software update function, e.g. for the purposes of optimisation, troubleshooting or security updates. To do this, you must be a registered Home Connect user, have installed the app on your mobile device and be connected to the Home Connect server. As soon as a software update is available, you will be informed via the Home Connect app and will be able to start the software update via the app. Once the update has been successfully downloaded, you can start installing it via the Home Connect app if you are in your WLAN home network (Wi-Fi). The Home Connect app will inform you once installation is successful.

### Notes

- You can continue to use your appliance as normal while updates are downloading. Depending on your personal settings in the app, software updates can also be set to download automatically.
- We recommend that you install security updates as soon as possible.

## 13.5 Remote diagnostics

Customer Service can use Remote Diagnostics to access your appliance if you contact them, have your appliance connected to the Home Connect server and if Remote Diagnostics is available in the country in which you are using the appliance.

**Tip:** For further information and details about the availability of Remote Diagnostics in your country, please visit the service/support section of your local website: [www.home-connect.com](http://www.home-connect.com)

## 13.6 Data protection

Please see the information on data protection. The first time your appliance is registered on a home network connected to the Internet, your appliance will transmit the following types of data to the Home Connect server (initial registration):

- Unique appliance identification (consisting of appliance codes as well as the MAC address of the Wi-Fi communication module installed).
- Security certificate of the Wi-Fi communication module (to ensure a secure data connection).
- The current software and hardware version of your appliance.
- Status of any previous reset to factory settings.

This initial registration prepares the Home Connect functions for use and is only required when you want to use the Home Connect functions for the first time.

**Note:** Please note that the Home Connect functions can only be utilised with the Home Connect app. Information on data protection can be retrieved in the Home Connect app.

---

# 14 Cleaning and servicing

To keep your appliance working efficiently for a long time, it is important to clean and maintain it carefully.

## 14.1 Cleaning products

In order to avoid damaging the various oven surfaces on the appliance, do not use unsuitable cleaning products.

### **WARNING – Risk of electric shock!**

An ingress of moisture can cause an electric shock.

- ▶ Do not use steam- or high-pressure cleaners to clean the appliance.

### **ATTENTION!**

Unsuitable cleaning products may damage the surfaces of the appliance.

- ▶ Do not use harsh or abrasive cleaning products.
- ▶ Do not use cleaning products with a high alcohol content.
- ▶ Do not use hard scouring pads or cleaning sponges.
- ▶ Do not use any special cleaners for cleaning the appliance while it is hot.

Using oven cleaner in a hot cooking compartment damages the enamel.

- ▶ Never use oven cleaner in the cooking compartment when it is still warm.
- ▶ Remove all food remnants from the cooking compartment and the appliance door before you next heat up the appliance.

New sponge cloths contain residues from production.

- ▶ Wash new sponge cloths thoroughly before use.

### **Suitable cleaning agents**

Only use cleaning products that are suitable for the different surfaces on your appliance.

Follow the instructions on cleaning the appliance.  
→ "Cleaning the appliance", Page 18



## Appliance front

Surface	Suitable cleaning agents	Information
Stainless steel	<ul style="list-style-type: none"> <li>▪ Hot soapy water</li> <li>▪ Special stainless steel cleaning products suitable for hot surfaces</li> </ul>	<p>To prevent corrosion, remove any patches of limescale, grease, starch or albumin (e.g. egg white) on stainless steel surfaces immediately.</p> <p>Apply a thin layer of the stainless steel cleaning product with a soft cloth.</p>
Plastic or painted surfaces E.g. control panel	<ul style="list-style-type: none"> <li>▪ Hot soapy water</li> </ul>	Do not use glass cleaner or a glass scraper.

## Appliance door

Area	Suitable cleaning agents	Information
Door panels	<ul style="list-style-type: none"> <li>▪ Hot soapy water</li> </ul>	<p>Do not use a glass scraper or a stainless steel wool.</p> <p><b>Tip:</b> Remove the door panels in order to clean them thoroughly. → "Appliance door", Page 20</p>
Door cover	<ul style="list-style-type: none"> <li>▪ Made of stainless steel: Stainless steel cleaner</li> <li>▪ Made of plastic: Hot soapy water</li> </ul>	<p>Do not use glass cleaner or a glass scraper.</p> <p><b>Tip:</b> Remove the door cover for thorough cleaning. → "Appliance door", Page 20</p>
Door handle	<ul style="list-style-type: none"> <li>▪ Hot soapy water</li> </ul>	To avoid permanent stains, remove descaling agents from the door handle immediately.
Door seal	<ul style="list-style-type: none"> <li>▪ Hot soapy water</li> </ul>	Do not remove or scrub.

## Cooking compartment

Area	Suitable cleaning agents	Information
Enamel surfaces	<ul style="list-style-type: none"> <li>▪ Hot soapy water</li> <li>▪ Vinegar water</li> <li>▪ Oven cleaner</li> </ul>	<p>Soak any heavily soiled areas and use a brush or steel wool.</p> <p>Leave the appliance door open to dry the cooking compartment after cleaning it.</p> <p><b>Tip:</b> It is best to use the cleaning function. → "Pyrolytic self-cleaning ", Page 18</p> <p><b>Notes</b></p> <ul style="list-style-type: none"> <li>▪ Enamel burns at very high temperatures, causing minor discoloration. The functionality of your appliance is not affected by this.</li> <li>▪ The edges of thin trays cannot be completely enamelled and may be rough. This does not impair corrosion protection.</li> <li>▪ Food residues will leave a white coating on the enamel surfaces. The coating does not pose a health risk. The functionality of your appliance is not affected by this. You can remove residues with lemon juice.</li> </ul>
Glass cover for the oven light	<ul style="list-style-type: none"> <li>▪ Hot soapy water</li> </ul>	Use oven cleaner to remove very heavy soiling.
Rails	<ul style="list-style-type: none"> <li>▪ Hot soapy water</li> </ul>	<p>Soak any heavily soiled areas and use a brush or steel wool.</p> <p><b>Tip:</b> Remove the shelf supports for cleaning. → "Shelf supports", Page 20</p>
Accessories	<ul style="list-style-type: none"> <li>▪ Hot soapy water</li> <li>▪ Oven cleaner</li> </ul>	<p>Soak any heavily soiled areas and use a brush or steel wool.</p> <p>Enamelled accessories are dishwasher-safe.</p>

## 14.2 Cleaning the appliance

In order to avoid damaging the appliance, you must clean your appliance only as specified, and with suitable cleaning products.

### **WARNING – Risk of burns!**

The appliance and its parts that can be touched become hot during use.

- ▶ Caution should be exercised here in order to avoid touching heating elements.
- ▶ Young children under 8 years of age must be kept away from the appliance.

### **WARNING – Risk of fire!**

Loose food remnants, fat and meat juices may catch fire.

- ▶ Before using the appliance, remove the worst of the food residues and remnants from the cooking compartment, heating elements and accessories.

**Requirement:** Read the information on cleaning products.

→ "Cleaning products", Page 16

1. Clean the appliance using hot soapy water and a dish cloth.
  - For some surfaces, you can use alternative cleaning agents.
    - "Suitable cleaning agents", Page 16
2. Dry with a soft cloth.

# 15 Cleaning functions

Use the cleaning functions to clean the appliance.

## 15.1 Pyrolytic self-cleaning

The **Pyrolytic self-cleaning** cleaning function cleans the cooking compartment almost by itself.

Use the cleaning function to clean the cooking compartment every two to three months. If required, you can use the cleaning function more frequently. The cleaning function requires approx. 2.5–4.8 kilowatt hours.

### Preparing the appliance for the cleaning function

In order to achieve a good cleaning result, prepare the appliance carefully.

#### **WARNING – Risk of fire!**

Combustible objects that are left in the cooking compartment may catch fire.

- ▶ Never store combustible objects in the cooking compartment.
- ▶ If smoke is emitted, the appliance must be switched off or the plug must be pulled out and the door must be held closed in order to stifle any flames.

Loose food remnants, fat and meat juices may catch fire when the cleaning function is in progress.

- ▶ Before you start the cleaning function, always remove coarse dirt from the cooking compartment.
- ▶ Never clean accessories at the same time.

The outside of the appliance gets very hot when the cleaning function is in progress.

- ▶ Never hang combustible objects, e.g. tea towels, on the door handle.
- ▶ Leave the front of the appliance clear.
- ▶ Keep children at a safe distance.

If the door seal is damaged, a large amount of heat is generated around the door.

- ▶ Do not scrub or remove the seal.
- ▶ Never operate the appliance if the seal is damaged or missing.

1. Remove accessories and cookware from the cooking compartment.
2. Unhook the shelf supports and remove them from the cooking compartment.
  - "Shelf supports", Page 20

3. Remove heavy soiling from the cooking compartment.
4. Use a detergent solution and a soft cloth to clean the surfaces at the edges of the cooking compartment around the door seal.
  - Do not remove or scrub the door seal.
  - Use oven cleaner to remove stubborn dirt from the inner door pane.
5. Remove any objects from the cooking compartment. The cooking compartment must be empty.

### Setting the cleaning function

Ventilate the kitchen while the cleaning function is running.

#### **WARNING – Risk of harm to health!**

The cleaning function heats up the cooking compartment to a very high temperature so that food left over from roasting, grilling and baking will burn off. This process releases vapours, which can irritate mucous membranes.

- ▶ Keep the kitchen well ventilated while the cleaning function is running.
- ▶ Do not remain in the room for long periods.
- ▶ Keep children and pets away.

#### **WARNING – Risk of burns!**

The cooking compartment gets very hot when the cleaning function is in progress.



- ▶ Never open the appliance door.
- ▶ Allow the appliance to cool down.
- ▶ Keep children at a safe distance.

 The outside of the appliance gets very hot when the cleaning function is in progress.

- ▶ Never touch the appliance door.
- ▶ Allow the appliance to cool down.
- ▶ Keep children at a safe distance.

**Note:** The oven light does not come on during the cleaning function.



**Requirement:** Prepare the appliance for the cleaning function. → Page 18

- Use the function selector to set the cleaning functions .
  - ✓ The  symbol and the cleaning functions appear in the display. The first cleaning function is highlighted.
- Press the > or < button repeatedly until the  symbol is highlighted.
  - ✓ PYRO appears in the display.
- Use the temperature selector to set the cleaning setting.

Cleaning setting	Cleaning level	Duration in hours
1	Lightly soiled	Approx. 1:15
2	Medium	Approx. 1:30
3	High	Approx. 2:00

Select a higher cleaning setting for very heavy or older soiling.

The duration cannot be changed.

- ✓ The cleaning function starts after a few seconds and the time counts down.
  - ✓ For safety reasons, the appliance door locks automatically once a certain temperature is reached in the cooking compartment.  appears in the display.
  - ✓ Once the cleaning function has ended, an audible signal sounds and the display shows the duration as zero.
- Switch off the appliance.  
Once the appliance has cooled down sufficiently, the appliance door unlocks and  goes out.
  - Prepare the appliance for use. → Page 19

### Preparing the appliance for use following the cleaning function

- Allow the appliance to cool down.
- Wipe off any ash that has been left behind in the cooking compartment and around the appliance door with a damp cloth.
- Remove white residues with lemon juice.  
**Note:** White residues on the enamel surfaces may be caused by heavy soiling. These food residues are harmless. The deposits do not compromise the functionality of the appliance.
- Attach the shelf supports.  
→ "Shelf supports", Page 20

## 15.2 Cleaning aid EasyClean

Use the cleaning aid **EasyClean** for intermediate cleaning of the cooking compartment. The cleaning aid **EasyClean** softens dirt by vaporising the soapy water. The dirt can then be removed more easily.

### Setting the cleaning aid EasyClean

#### WARNING – Risk of scalding!

If there is water in the cooking compartment when it is hot, this may create hot steam.

- ▶ Never pour water into the cooking compartment when the cooking compartment is hot.

#### Notes

- The interior lighting remains off while the cleaning aid is running.
- You cannot delay the end time.

- The length of time has been preset and cannot be changed.

#### Requirements

- You can only start the cleaning aid once the cooking compartment is cold (room temperature) and the appliance door is closed.
- Do not open the appliance door while the appliance is in operation. Otherwise, the appliance will stop the cleaning aid.
- To remove particularly stubborn dirt, leave the soapy water to work for some time before starting the cleaning aid.
- To remove particularly stubborn dirt, rub soapy water onto the dirt on smooth surfaces before starting the cleaning aid.

- Remove the accessories from the cooking compartment.

#### 2. ATTENTION!

Distilled water in the cooking compartment leads to corrosion.

- ▶ Do not use distilled water.

Mix 0.4 litres water with a drop of washing-up liquid and pour into the centre of the cooking compartment floor.

- Use the function selector to set the cleaning functions .

- ✓ The  symbol and the cleaning functions appear in the display. The first cleaning function is highlighted.

- Press the < or > button repeatedly until the  symbol is highlighted.

- ✓ EASY appears in the display.

- Turn the temperature selector.

- ✓  appears in the display.

- ✓ The cleaning aid starts after a few seconds. The duration counts down in the display.

- ✓ Once the cleaning aid has run through to the end, an audible signal sounds.

**Note:** If  flashes in the display when the cleaning aid is switched on, this indicates that the cooking compartment has not completely cooled down. Switch off the appliance. Wait until the cooking compartment has cooled down and switch the cleaning aid back on.

### Recleaning the cooking compartment

#### ATTENTION!

The prolonged presence of moisture in the cooking compartment leads to corrosion.

- ▶ After using the cleaning aid, wipe the cooking compartment clean and allow it to dry fully.

- Open the appliance door and remove the remaining water with an absorbent sponge cloth.
- Clean the smooth surfaces in the cooking compartment with a dish cloth or a soft brush. Stubborn residues can be removed using a stainless steel scouring pad.
- Remove limescale with a cloth soaked in vinegar. Then wipe with clean water and rub dry with a soft cloth (including under the door seal).
- If you are unable to remove stubborn dirt, repeat the cleaning aid after the cooking compartment has cooled down.
- To switch off, turn the function selector to the zero setting.

6. Lower the appliance door and leave it open for approx. one hour to allow the surfaces in the cooking compartment to dry thoroughly.

## 16 Shelf supports

To clean the rails and the cooking compartment, or to replace the rails, you can remove these.

### 16.1 Detaching the shelf supports

#### **⚠ WARNING – Risk of burns!**

The shelf supports get very hot

- ▶ Never touch the shelf supports when hot.
- ▶ Always allow the appliance to cool down.
- ▶ Keep children at a safe distance.

1. Lift the rail forwards slightly ① and detach it ②.
2. Pull the whole rail to the front ③ and remove it.

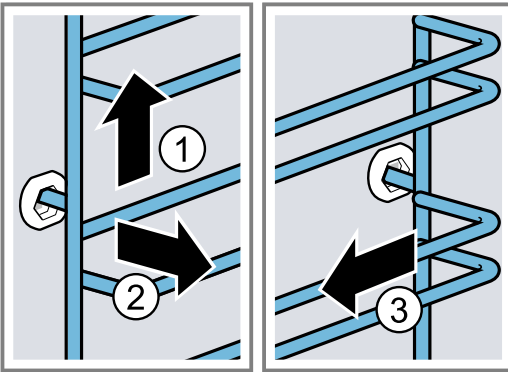

3. Clean the rail.  
→ "Cleaning products", Page 16

### 16.2 Attaching the shelf supports

#### **Notes**

- The rails only fit on the right or left.
- For both rails, ensure that the curved rods are at the front.

1. First, push the rail into the middle of the rear socket ① until the rail rests against the cooking compartment wall, and then push this back ②.
2. Push the rail into the front socket ③ until the rail also rests against the cooking compartment wall, and then press this downwards ④.

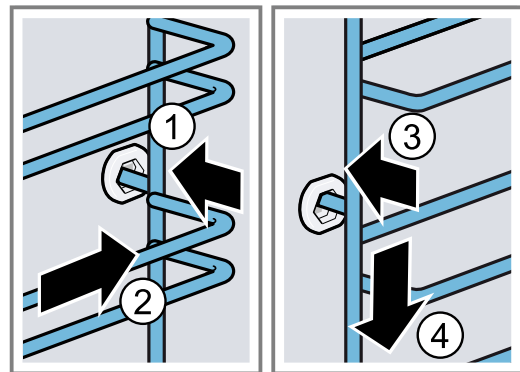

## 17 Appliance door

To ensure that your appliance retains its appearance and remains fully functioning for a long time, you can detach the appliance door and clean it.

#### **⚠ WARNING – Risk of injury!**

If the hinges are not secured due to an incomplete lock, they can snap shut with great force.

- ▶ To detach or attach the appliance door, always turn the two locks as far as they will go.
- ▶ If the hinge snaps closed when detaching or attaching the appliance door, do not reach into the hinge – call the after-sales service.

### 17.1 Detaching the appliance door

#### **Requirements**

- Have a torch ready.
- Have a screwdriver ready.
- Have a coin ready.

1. To make it easier to see the door lock, shine the torch into the gap beside the appliance door.

2. Hold the screwdriver horizontally ① and use it to push the door lock (black component) on each side of the door upwards as far as it will go ②.

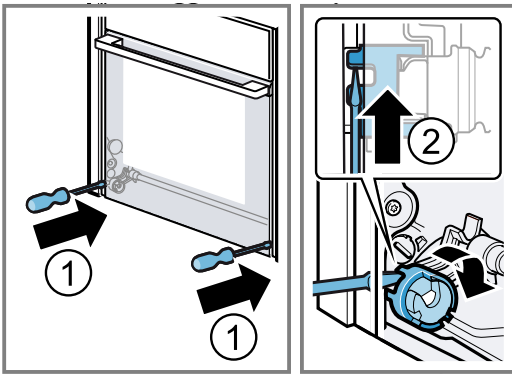

Door lock open

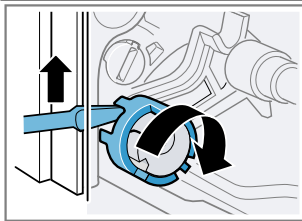

Door lock closed

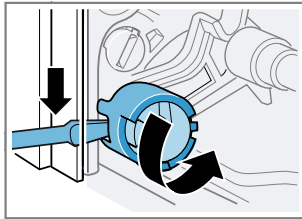

3. Open the appliance door approx. 45° wide.

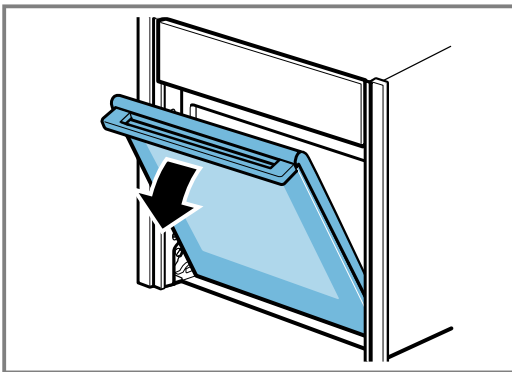

4. Insert the coin in the gap in the lock ① and rotate as far as it will go ②.
- Turn the lock on the left-hand side in a clockwise direction.
  - Turn the lock on the right-hand side in an anti-clockwise direction.

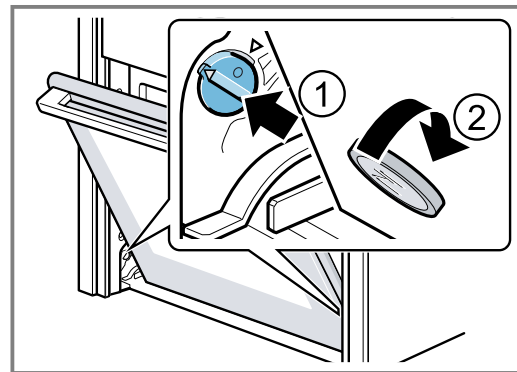
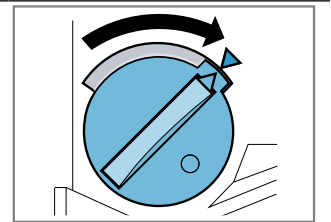
Left-hand lock secured  
The arrows point to each other

Left-hand lock released

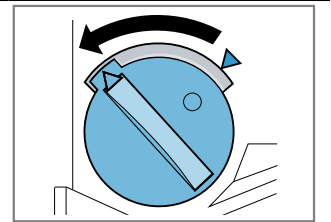

- ✓ The lock audibly engages.

5. **ATTENTION!**

- Opening and closing the appliance door when it is in the lock position damages the door hinges.
- ▶ Never force the appliance door open or closed.
  - ▶ If the door hinge has been damaged, call the after-sales service.

Move the appliance door up and down until you hear a quiet click. You can still only move the appliance door slightly.

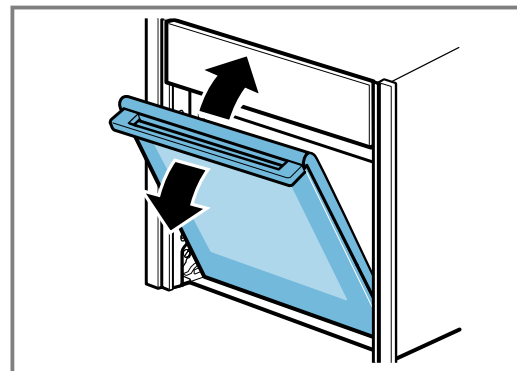

- ✓ The appliance door is in the lock position.

**6. ⚠ WARNING – Risk of injury!**

The appliance door has a weight of 7–10 kg and may fall if it is not handled carefully.

- ▶ Handle the appliance door carefully.

The door handle is not suitable for carrying the appliance door. The door handle may break off.

- ▶ Never carry the appliance door by the door handle.
- ▶ Grab hold of the appliance door with both hands on the left and right to carry it.

Take hold of the appliance door with both hands, one on the left and one on the right, and rotate the door handle upwards ① until you are able to pull up the appliance door and remove it ②.

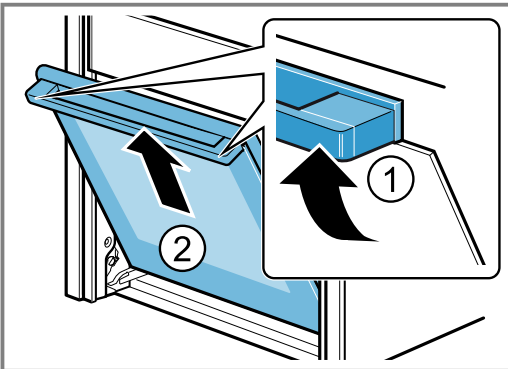

7. Set the appliance door down on a flat, soft, clean surface.

## 17.2 Attaching the appliance door

1. **Tip:** Ensure that the appliance door is not wedged at an angle and that it is properly fitted in place.

Attach the appliance door via the left- and right-hand guide rollers simultaneously [a].

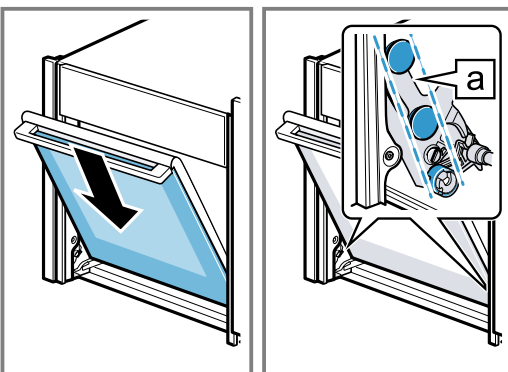

2. Rotate the door handle upwards slightly ①.

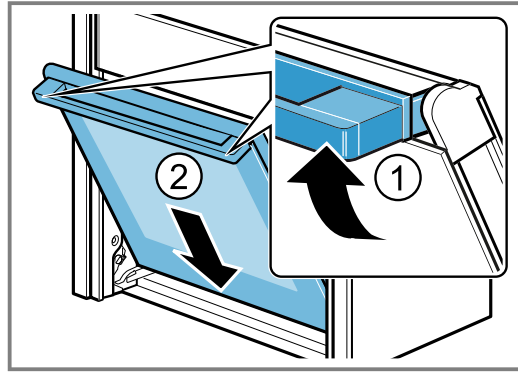

- ✓ The appliance door will slide the short distance remaining to the bottom ②.
3. Use a coin to release both locks on the appliance door. Insert the coin in the gap in the lock ① and rotate as far as it will go ②.
- Turn the lock on the left-hand side in an anti-clockwise direction.
  - Turn the lock on the right-hand side in a clockwise direction.

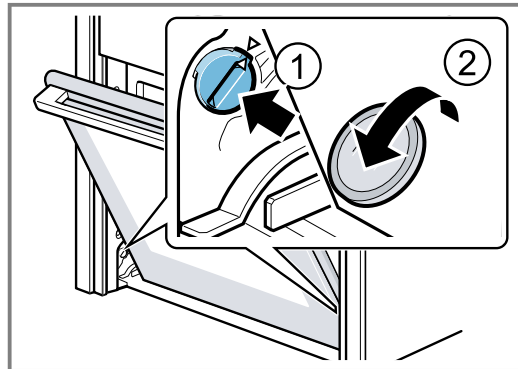

4. Open the appliance door slightly until you hear a quiet click, and then close the appliance door.

5. **⚠ WARNING – Risk of injury!**

If the door locks are unsecured, the appliance door may become detached.

- ▶ After attaching the appliance door, close the left- and right-hand door locks.

Hold the screwdriver horizontally ① and use it to push the door lock (black component) on each side of the door downwards as far as it will go ②.

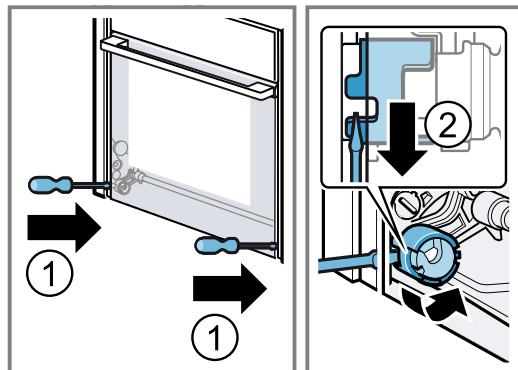

- ✓ The door lock is closed.

## 17.3 Removing the door panes

To facilitate cleaning, you can remove the door pane.

### **⚠ WARNING – Risk of injury!**

Components inside the appliance door may have sharp edges.

- ▶ Wear protective gloves.

### Requirements

- Have a screwdriver ready.
- The appliance door is detached.  
→ "Detaching the appliance door", Page 20

1. Lay the appliance door with the front side facing down on a flat surface that is soft and clean.
2. Undo and remove the left- and right-hand screws on the appliance door.

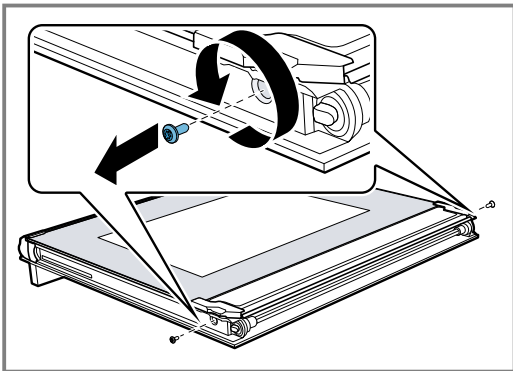

3. Carefully lift the inner pane upwards at an angle ① and remove the holder **a** ②.
4. Carefully lift the inner pane upwards at an angle and remove it in the direction of the arrow ③.

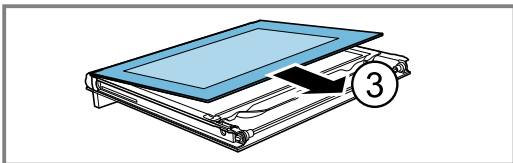
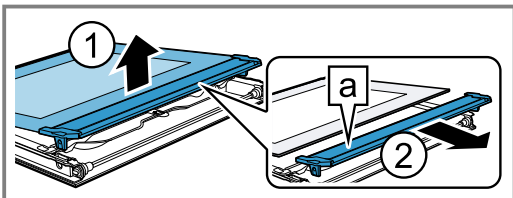

5. Push down on the intermediate pane in the area of **a**, and carefully lift the retainer **b** until you are able to pull it out.

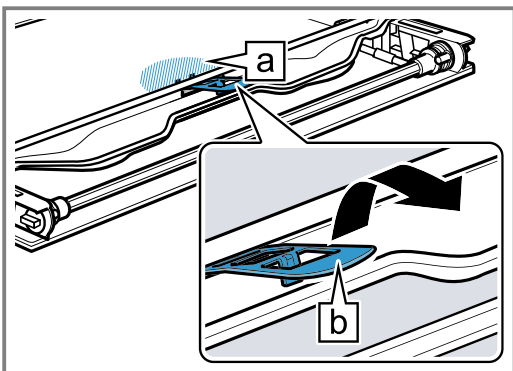

6. Lift the first and second intermediate panes from below ① and remove them in the direction of the arrow ②.

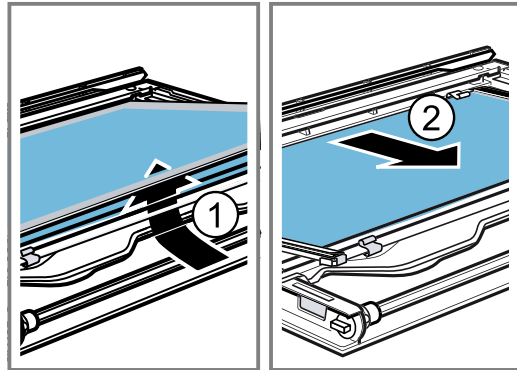

7. Remove the spacers **a** and seals **b** for cleaning, if required.

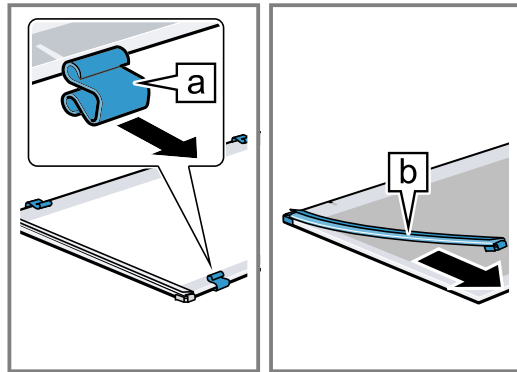

8. **⚠ WARNING – Risk of injury!**  
Scatched glass in the appliance door may develop into a crack.

- ▶ Do not use any harsh or abrasive cleaners or sharp metal scrapers to clean the glass on the oven door, as they may scratch the surface.

Clean the door panes on both sides with glass cleaner and a soft cloth.

9. Dry the door panes and refit them.

## 17.4 Fitting the door panes

### **⚠ WARNING – Risk of injury!**

If a door pane or appliance door has not been installed correctly, this is dangerous.

- ▶ Make sure that all of the door panes and the appliance door have been correctly fitted before you switch the appliance back on again.

1. **Tip:** When fitting the door panes, make sure that they are in the original order.  
 Insert the intermediate pane so that the **a** arrow on the right-hand side is pointing upwards.

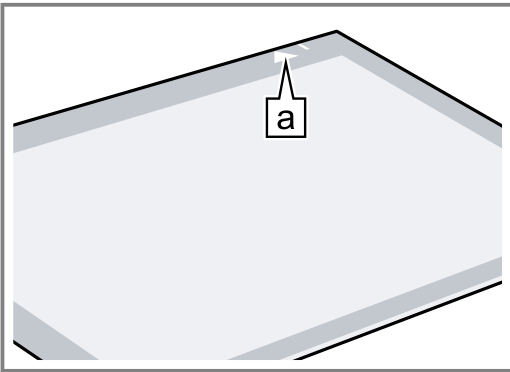

2. Check the fit of the four spacers and two seals.  
 – Place the spacers on the centre of the lines **a** ①.  
 – Secure the seals at the corners ②.

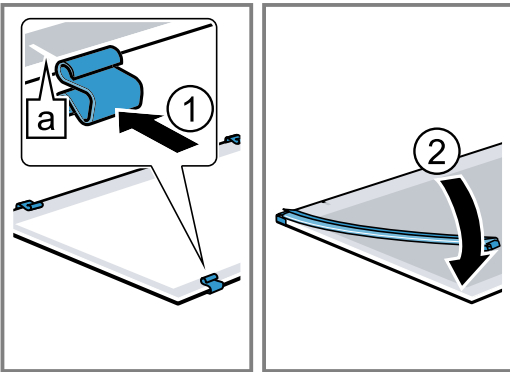

3. Insert the intermediate pane with spacers and seals in the direction of the arrow ①.  
 The arrow on the intermediate pane must line up with the arrow on the frame **a**.  
 4. Insert the second intermediate pane without the spacers and seals, and slide it in the direction of the arrow until it is inserted in the frame ②.

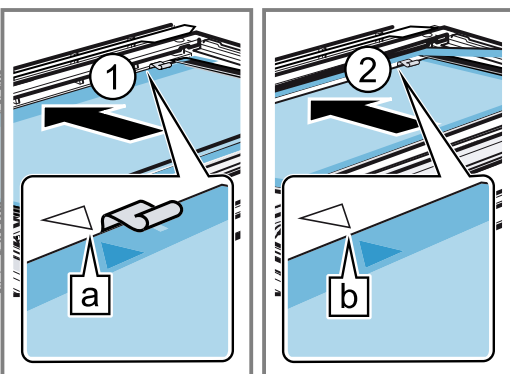

The arrow on the intermediate pane must line up with the arrow on the frame **b**.

5. Push down on the intermediate pane around **a**, slide the retainer **b** in at an angle and push down until it clicks into place.

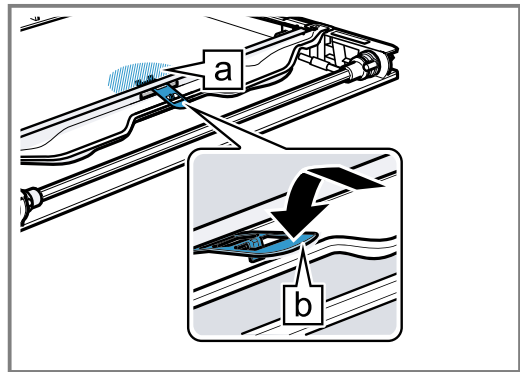

- ✓ The retainer has been inserted.

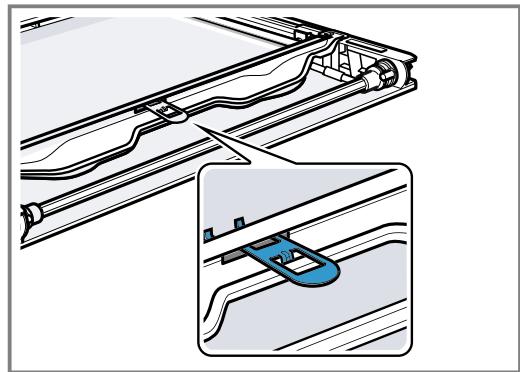

6. Place the inner pane onto the appliance door so that the number **a** is legible at the bottom right. Insert the inner pane into the fixing rail **b** at an angle towards the back.

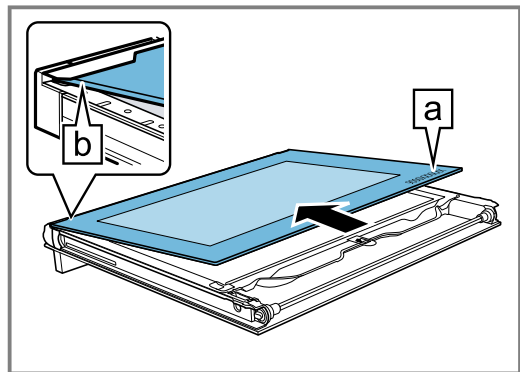

7. Carefully lift the inner pane upwards at an angle and attach the holder **a**.

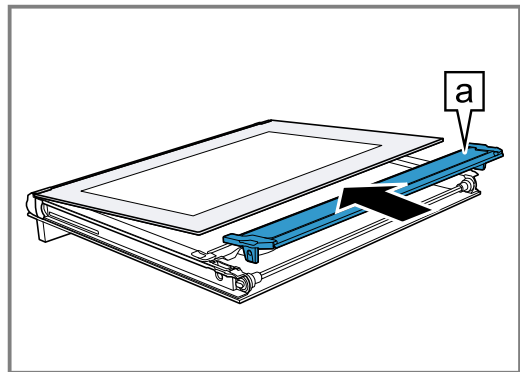



8. Insert the inner pane with the holder **a** into the opening.

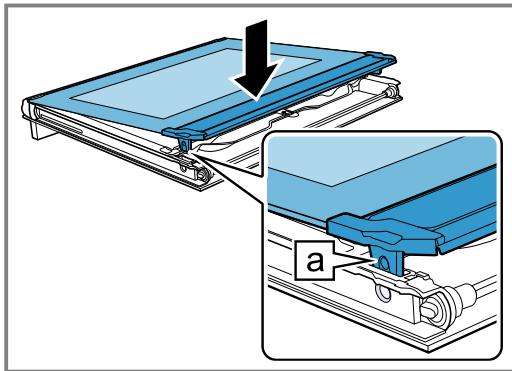

9. Screw both screws back in on the left and right of the appliance door.

## 18 Troubleshooting

You can rectify minor faults on your appliance yourself. Read the troubleshooting information before contacting after-sales service. This will avoid unnecessary costs.

### **⚠ WARNING – Risk of injury!**

Improper repairs are dangerous.

- ▶ Repairs to the appliance should only be carried out by trained specialist staff.
- ▶ If the appliance is defective, call Customer Service.

### **⚠ WARNING – Risk of electric shock!**

Incorrect repairs are dangerous.

- ▶ Repairs to the appliance should only be carried out by trained specialist staff.
- ▶ Only use genuine spare parts when repairing the appliance.
- ▶ If the power cord of this appliance is damaged, it must be replaced by trained specialist staff.

### 18.1 Malfunctions

Fault	Cause and troubleshooting
The appliance is not working.	The circuit breaker in the fuse box has tripped. ▶ Check the circuit breaker in the fuse box.
	There has been a power cut. ▶ Check whether the lighting in your kitchen or other appliances are working.
The appliance does not heat up; <b>MEMO</b> lights up in the display.	Demo mode is activated. 1. Briefly disconnect the appliance from the power supply by switching the circuit breaker in the fuse box off and then on again. 2. Deactivate demo mode within 5 minutes by changing the last basic setting (depending on the appliance type <b>e 13</b> or <b>e 14</b> ) to <b>0</b> . → "Basic settings", Page 13
The appliance door cannot be opened; <b>⊘</b> lights up in the display.	The childproof lock locks the appliance door. ▶ Use the <b>⊖</b> button to deactivate the childproof lock. → "Childproof lock", Page 12
The appliance door cannot be opened; <b>⊘</b> lights up in the display.	The cleaning function locks the appliance door. ▶ Allow the appliance to cool down until <b>⊘</b> goes out in the display. → "Pyrolytic self-cleaning", Page 18
The time flashes in the display.	There has been a power cut. ▶ Reset the time. → "Setting the time on the clock", Page 12
The time does not appear in the display when the appliance is switched off.	The basic setting has been changed. ▶ Change the basic setting for the time display. → "Basic settings", Page 13

Fault	Cause and troubleshooting
↔ lights up in the display and no settings can be made on the appliance.	<p>Childproof lock is activated.</p> <ul style="list-style-type: none"> <li>▶ Use the ☹ button to deactivate the childproof lock. → "Childproof lock", Page 12</li> </ul>
H flashes in the display and the appliance does not start.	<p>The cooking compartment is too hot for the selected operation.</p> <ol style="list-style-type: none"> <li>1. Switch off the appliance and allow it to cool down.</li> <li>2. Restart the operation.</li> </ol>
F ⏸ appears in the display.	<p>The maximum cooking time has been reached. To prevent an unwanted permanent operation, the appliance automatically stops heating after several hours if the settings are unchanged.</p> <ul style="list-style-type: none"> <li>▶ Switch off the appliance. You can configure new settings if required.</li> </ul> <p><b>Tip:</b> To prevent the appliance from switching off when you do not want it to, e.g. for an extremely long preparation time, set a cooking time. → "Time-setting options", Page 11</p>
A message with E appears in the display, e.g. E05-32.	<p>Electronics fault</p> <ol style="list-style-type: none"> <li>1. Press the ☹ button. <ul style="list-style-type: none"> <li>- If required, reset the time.</li> </ul> </li> <li>✓ If the fault was a one-off, the error message disappears.</li> <li>2. If the error message appears again, call the after-sales service. Quote the exact error message and the E no. of your appliance. → "Customer Service", Page 27</li> </ol>
HomeConnect is not working correctly.	<p>Different causes are possible.</p> <ul style="list-style-type: none"> <li>▶ Go to <a href="http://www.home-connect.com">www.home-connect.com</a>.</li> </ul>

## 18.2 Replacing the oven light bulb

If the light in the cooking compartment fails, change the oven light bulb.

**Note:** Heat-resistant, 40-watt, 230 V halogen bulbs are available from the after-sales service or specialist retailers. Only use these bulbs. Hold the new halogen bulbs only with a clean, dry towel. This increases the service life of the bulb.

### ⚠ WARNING – Risk of burns!

The appliance and its parts that can be touched become hot during use.

- ▶ Caution should be exercised here in order to avoid touching heating elements.
- ▶ Young children under 8 years of age must be kept away from the appliance.

### ⚠ WARNING – Risk of electric shock!

When changing the bulb, the bulb socket contacts are live.

- ▶ Before replacing the bulb, ensure that the appliance is switched off in order to prevent a potential electric shock.
- ▶ Also unplug the appliance from the mains or switch off the circuit breaker in the fuse box.

### Requirements

- The appliance is disconnected from the power supply.
- The cooking compartment has cooled down.
- You have a new halogen bulb to replace the old one.

1. Place a tea towel in the cooking compartment to prevent damage.
2. Turn the glass cover anti-clockwise to remove it ①.
3. Pull out the halogen bulb without turning it ②.

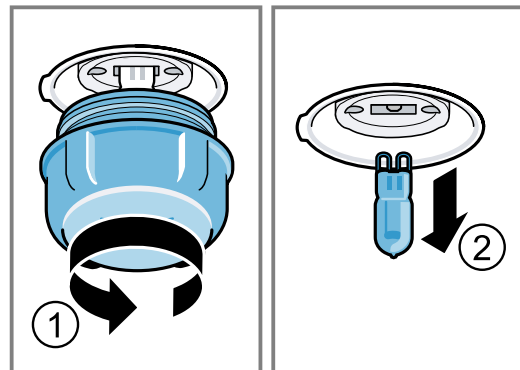

4. Insert the new halogen lamp and press it firmly into the socket. Make sure the pins are positioned correctly.
5. Depending on the appliance model, the glass cover may have a sealing ring. Put the sealing ring in position.
6. Screw the glass cover on.
7. Take the tea towel out of the cooking compartment.
8. Connect the appliance to the power supply.

## 19 Disposal

Find out here how to dispose of old appliances correctly.

### 19.1 Disposing of old appliance

Valuable raw materials can be reused by recycling.

1. Unplug the appliance from the mains.
2. Cut through the power cord.
3. Dispose of the appliance in an environmentally friendly manner.

Information about current disposal methods are available from your specialist dealer or local authority.



This appliance is labelled in accordance with European Directive 2012/19/EU concerning used electrical and electronic appliances (waste electrical and electronic equipment - WEEE).

The guideline determines the framework for the return and recycling of used appliances as applicable throughout the EU.

## 20 Customer Service

If you have any queries on use, are unable to rectify faults on the appliance yourself or if your appliance needs to be repaired, contact Customer Service.

Function-relevant genuine spare parts according to the corresponding Ecodesign Order can be obtained from Customer Service for a period of at least 10 years from the date on which your appliance was placed on the market within the European Economic Area.

**Note:** Under the terms of the manufacturer's warranty the use of Customer Service is free of charge.

Detailed information on the warranty period and terms of warranty in your country is available from our after-sales service, your retailer or on our website.

If you contact Customer Service, you will require the product number (E-Nr.) and the production number (FD) of your appliance.

The contact details for Customer Service can be found in the enclosed Customer Service directory or on our website.

### 20.1 Product number (E-Nr.) and production number (FD)

You can find the product number (E-Nr.) and the production number (FD) on the appliance's rating plate. The rating plate bearing these numbers can be found on the base of the appliance when you open the appliance door.



Make a note of your appliance's details and the Customer Service telephone number to find them again quickly.

## 21 Declaration of Conformity

Constructa Neff Vertriebs-GmbH hereby declares that the appliance with Home Connect functionality conforms to the basic requirements and other relevant provisions of Directive 2014/53/EU.

A detailed RED Declaration of Conformity can be found online at [www.neff-international.com](http://www.neff-international.com) among the additional documents on the product page for your appliance.



Hereby, Constructa Neff Vertriebs-GmbH declares that the appliance with Home Connect functionality is in compliance with relevant statutory requirements.<sup>1</sup> A detailed Declaration of Conformity can be found online at [www.neff-home.com/uk](http://www.neff-home.com/uk) among the additional documents on the product page for your appliance.<sup>1</sup>



Only applies to Great Britain

2.4 GHz band (2400–2483.5 MHz): Max. 100 mW  
5 GHz band (5150–5350 MHz + 5470–5725 MHz):  
Max. 100 mW



BE	BG	CZ	DK	DE	EE	IE	EL	ES
FR	HR	IT	CY	LI	LV	LT	LU	HU
MT	NL	AT	PL	PT	RO	SI	SK	FI

<sup>1</sup> Only applies to Great Britain

SE	NO	CH	TR	IS	UK (NI)		
5 GHz WLAN (Wi-Fi): For indoor use only.							
AL	BA	MD	ME	MK	RS	UK	UA
5 GHz WLAN (Wi-Fi): For indoor use only.							

## 22 How it works

Here, you can find the ideal settings for various types of food as well as the best accessories and cookware. We have perfectly tailored these recommendations to your appliance.

### 22.1 Cooking tips

Observe this information when preparing food.

- The temperature and cooking time depend on the amount of food and the recipe. Settings ranges are specified for this reason. Try using the lower values to start with.
- The setting values apply to food placed in the cooking compartment while the cooking compartment is still cold. Do not slide the accessory into the cooking compartment until it has finished preheating.
- Remove any accessories that are not being used from the cooking compartment.

### 22.2 Notes on baking

When baking, use the shelf positions indicated.

Baking on one level	Height
Deep baked goods or tin on wire rack	2
Flat baked goods or goods in a baking tray	3

Baking on two levels	Height
Universal pan	3
Baking tray	1
Baking tins/dishes on the wire rack:	Height
First wire rack	3
Second wire rack	1

Baking on three levels	Height
Baking tray	4
Universal pan	3
Baking tray	1

#### Notes

- When baking on several layers, always use hot air. Baked goods that are placed in the oven at the same time will not necessarily be ready at the same time.
- Position baking tins/dishes either next to one another or offset on different shelves so that they are not directly one above the other in the cooking compartment.
- For best results, we recommend using dark-coloured metal bakeware.

### 22.3 Notes on roasting and grilling

The setting values are based on the assumption that unstuffed, chilled, ready-to-roast poultry, meat or fish is placed into a cold cooking compartment.

- The larger the poultry, meat or fish, the lower the cooking temperature and the longer the cooking time.
- Turn the poultry, meat or fish after approx. 1/2 to 2/3 of the time listed.
- Add a little liquid to the poultry in the cookware. Cover the bottom of the cookware with approx. 1–2 cm of liquid.
- When you turn poultry, ensure that the breast side or skin side is underneath to begin with.
- Cooking time calculation (e.g. 20 + 35): To calculate the cooking time, assume 20 minutes per 500 g of meat plus an extra 35 minutes. For 1.5 kg, the cooking time is then 95 minutes.
- Cooking time range (e.g. 10–15): Your food will be ready within the specified range of time.

#### Roasting and grilling on the wire rack

Roasting on the wire rack works particularly well for large poultry or for multiple pieces at the same time.

- Depending on the size and type of the food to be roasted, add up to 1/2 litre water to the universal pan. You can make a sauce from the juices that are caught. This also means that less smoke is produced and the cooking compartment becomes less dirty.
- Keep the appliance door closed when using the grill. Never grill with the appliance door open.
- Place the food to be grilled on the wire rack. In addition, slide the universal pan in at least one shelf position lower, with the slanted edge facing the appliance door. This means that any dripping fat is caught.

#### Roasting in cookware

When preparing food in cookware with a lid, the cooking compartment remains cleaner. Follow the manufacturer's instructions for your roasting dishes. Glass cookware is best.

#### Cookware without lid

- Use a deep roasting dish.
- Place the cookware onto the wire rack.
- If you do not have any suitable cookware, use the universal pan.

#### Cookware with lid

- Place the cookware onto the wire rack.

- Meat, poultry and fish can also become crispy in a covered roasting dish. Use a roasting dish with a glass lid. Set a higher temperature.

### **WARNING – Risk of injury!**

If hot glass cookware is placed on a wet or cold surface, the glass may shatter.























- Place hot glass ovenware on a dry mat after cooking.

### **WARNING – Risk of scalding!**

Very hot steam may escape when the lid is opened after cooking. Steam may not be visible, depending on the temperature.

- Lift the lid in such a way that the hot steam can escape away from you.
- Keep children away from the appliance.

## 22.4 Food selection

Food	Accessories/cookware	Shelf position	Type of heating	Temperature in °C/grill setting	Cooking time in mins
Victoria sponge cake	2 pcs Ø 20 cm cake tin	2		150-170 <sup>1</sup>	15-25
Rich fruit cake	Deep 23 cm diameter tin	2		140-150	180-210
Fruit pie	20 cm diameter plate or pie tin	2		160-170	60-70
Quiche	Quiche tin (dark-coated)	3		180-200	40-55
(White) bread	Loaf tin (1 x 900 g or 2 x 450 g)	2		190-210 <sup>1</sup>	25-40
Scones	Baking sheet on wire rack	3		190-200 <sup>2</sup>	10-15
Biscuits	Baking sheet on wire rack	3		140-160 <sup>1</sup>	10-20
Small cakes	12-cup tin	3		150 <sup>3</sup>	25-35
Pavlova	Baking sheet on wire rack	3		100-110 <sup>4</sup>	150-180
Yorkshire pudding	12-cup tin	3		200-220 <sup>5</sup>	15-25
Pizza, home-made	Baking tray	3		190-210	20-30
Pizza, home-made, thin base	Round pizza tray	2		250-270	8-13
Victoria sponge cake, 2 levels	4 pcs Ø 20 cm cake tin	3+1		150-160 <sup>2</sup>	20-30
Biscuits, 2 or 3 levels	Baking sheet on wire rack	3+1 4+3+1		140-160 <sup>2</sup>	15-25
Beef, top side/top rump	Cookware without lid	2		170	40+30
Lamb leg (on the bone)	Cookware without lid	2		160-170	25+15
Pork belly	Cookware without lid	2	<b>1.</b>  <b>2.</b> 	<b>1.</b> 170-180 <b>2.</b> 250	<b>1.</b> 30+30 <sup>6</sup> <b>2.</b> 3-5
Chicken, whole	Wire rack	2		170-180	25+15 <sup>7</sup>
Turkey, crown	Wire rack	2		140-150	20+25
Turkey, whole, 4–8 kg	Wire rack	1		150-160	12+12 <sup>8</sup>
Fish, braised, whole 300 g, e. g. trout	Cookware with lid	2		170-190	25-35
Diced meat (beef, pork, lamb), 500 g	Cookware with lid	2		140	120-140

<sup>1</sup> Preheat the appliance. Do not use the rapid heating function.

<sup>2</sup> Preheat the appliance.

<sup>3</sup> Preheat the appliance for five minutes. Do not use the rapid heating function.

<sup>4</sup> Preheat the appliance to 150 °C using HotAir.

<sup>5</sup> Preheat the appliance for 20 minutes.

<sup>6</sup> Do not turn the food.







<sup>7</sup> Slide the universal pan underneath the wire rack.

<sup>8</sup> Add the food after approx. one hour.

<sup>9</sup> Preheat the appliance for 5 minutes.

<sup>10</sup> Preheat the appliance for three minutes.

<sup>11</sup> Turn the food occasionally.

Food	Accessories/cookware	Shelf position	Type of heating	Temperature in °C/grill setting	Cooking time in mins
Complete meal with chicken	Wire rack + Wire rack + Universal pan	4+1		180, then 200 (Yorkshire pudding)	Chicken: (25+25) + 20 for Yorkshire pudding
Bacon rashers	Wire rack	3		Int/  <sup>9</sup>	1 side 4-5 2 side 3-4
Sausages, thickness 2-4 cm	Wire rack	3		Int/  <sup>10</sup>	10-15 <sup>11</sup>
Pork, gammon joint	Cookware without lid	2		170-180	25+20 <sup>6</sup>
Chicken, whole	Cookware without lid	2		170-180	20+20 <sup>7</sup>

<sup>1</sup> Preheat the appliance. Do not use the rapid heating function.

<sup>2</sup> Preheat the appliance.

<sup>3</sup> Preheat the appliance for five minutes. Do not use the rapid heating function.

<sup>4</sup> Preheat the appliance to 150 °C using HotAir.

<sup>5</sup> Preheat the appliance for 20 minutes.

<sup>6</sup> Do not turn the food.

<sup>7</sup> Slide the universal pan underneath the wire rack.

<sup>8</sup> Add the food after approx. one hour.

<sup>9</sup> Preheat the appliance for 5 minutes.

<sup>10</sup> Preheat the appliance for three minutes.

<sup>11</sup> Turn the food occasionally.

## 22.5 Yoghurt

You can use your appliance to make your own yoghurt.

### Preparing yoghurt

1. Remove the accessories and shelf supports from the cooking compartment.
2. Pour the previously prepared yoghurt mixture into small containers, e.g. into cups or small jars.

3. Cover the containers with foil, e. g. with cling film.
4. Place the containers on the cooking compartment floor.
5. Set the appliance according to the recommended setting.
6. After making the yoghurt, leave it to cool in the refrigerator.

### Recommended settings for yoghurt

Food	Accessories/cookware	Shelf position	Type of heating	Temperature in °C	Cooking time in mins
Yoghurt	Individual moulds	Cooking compartment floor	=	40-45	8-9 hrs

## 22.6 Test dishes

These overviews have been produced for test institutes to facilitate appliance testing in accordance with EN 60350-1.

### Baking

Observe this information when baking test dishes.

#### General information

- The settings apply to food that is placed into a cold cooking compartment.
- Observe the notes about preheating in the tables. These setting values apply without rapid heating.
- When baking, use the lower of the listed temperatures to begin with.

#### Shelf positions

Shelf positions for baking on two levels:

**Note:** Items that are placed in the oven on baking trays or in baking tins/dishes at the same time will not necessarily be ready at the same time.

- Universal pan: Level 3  
Baking tray: Level 1
- Baking tins/dishes on the wire rack  
First wire rack: Level 3  
Second wire rack: Level 1

Shelf positions for baking on three levels:

- Baking tray: Level 4  
Universal pan: Level 3  
Baking tray: Level 1

Baking with two springform cake tins:

Position baking tins/dishes either next to one another or offset on different shelves so that they are not directly one above the other in the cooking compartment.

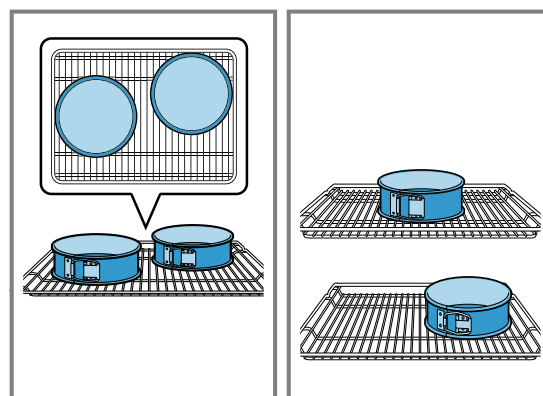

### Recommended settings for baking

Food	Accessories/cookware	Shelf position	Type of heating	Temperature in °C	Cooking time in mins
Viennese whirls	Baking tray	3	≡	140-150 <sup>1</sup>	25-35
Viennese whirls	Baking tray	3	⌘	140-150 <sup>1</sup>	20-30
Viennese whirls, 2 levels	Universal pan + Baking tray	3 + 1	⌘	140-150 <sup>1</sup>	25-35
Viennese whirls, 3 levels	Universal pan + Baking tray	4 + 3 + 1	⌘	130-140 <sup>1</sup>	35-55
Small cakes	Baking tray	3	≡	150 <sup>1</sup>	25-35
Small cakes	Baking tray	3	⌘	140 <sup>1</sup>	25-35
Small cakes, 2 levels	Universal pan + Baking tray	3 + 1	⌘	140 <sup>1</sup>	30-40
Small cakes, 3 levels	Universal pan + Baking tray	4 + 3 + 1	⌘	140 <sup>1</sup>	30-40
Hot water sponge cake	Springform cake tin, diameter 26 cm	2	≡	160-170 <sup>2</sup>	25-35
Hot water sponge cake	Springform cake tin, diameter 26 cm	2	⌘	160-170	30-35
Hot water sponge cake, 2 levels	Springform cake tin, diameter 26 cm	3 + 1	⌘	150-160 <sup>2</sup>	35-50

<sup>1</sup> Preheat the appliance for five minutes. Do not use the rapid heating function.

<sup>2</sup> Preheat the appliance. Do not use the rapid heating function.

### Recommended settings for grilling

Food	Accessories/cookware	Shelf position	Type of heating	Temperature in °C/grill setting	Cooking time in mins
Toasting bread	Wire rack	4	⚡	Int./ <sup>1</sup>	5-6

<sup>1</sup> Do not preheat the appliance.

## 23 Installation instructions

Observe this information when installing the appliance.



### **⚠ 23.1 General installation instructions**

Follow these instructions before you start with the installation of the appliance.

- The safe operation of this appliance can only be guaranteed if it has been installed to a professional standard in accordance with these installation instructions. The installer shall be liable for damages incurred as a result of incorrect installation.
- Do not use the door handle for the transport or installation.
- Check the appliance for damage after unpacking it. Do not connect the appliance if it has been damaged in transit.
- Before starting up the appliance, remove any packaging material and adhesive film from the cooking compartment and the door.
- Proceed in accordance with the installation sheets for installing accessories.
- Fitted units must be heat-resistant up to 95 °C, and adjacent unit fronts up to 70 °C.
- Do not install the appliance behind a decorative door or the door of a kitchen unit. There is a risk of overheating.
- Cut-out work on the units should be carried out before installing the appliance. Remove any shavings. Otherwise, the correct operation of electrical components may be adversely affected.
- The mains socket for the appliance must either be located in the hatched area **a** or outside of the area where the appliance is installed.  
Any unsecured units must be secured to the wall using a standard bracket **b**.

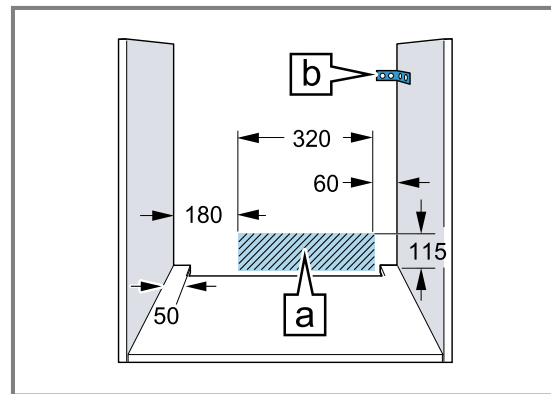

- Wear protective gloves so that you do not cut yourself. Parts that are accessible during installation may have sharp edges.
- Dimensions of the figures in mm.

### **⚠ WARNING – Risk of fire!**

It is dangerous to use an extended power cord and non-approved adapters.

- ▶ Do not use multiple socket strips.
- ▶ Only use extension cables that are certified, have a minimum cross section of 1.5 mm<sup>2</sup> and comply with the applicable national safety requirements.
- ▶ If the power cord is too short, contact customer service.
- ▶ Only use adapters approved by the manufacturer.

### **ATTENTION!**

Carrying the appliance by the door handle could break it. The door handle cannot support the weight of the appliance.

- ▶ Do not carry or hold the appliance by the door handle.

### **23.2 Appliance dimensions**

You will find the dimensions of the appliance here

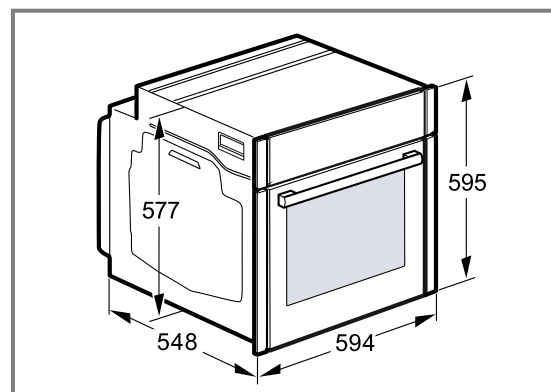



### 23.3 Installation below a worktop

Observe the installation dimensions and the installation instructions when installing below a worktop.

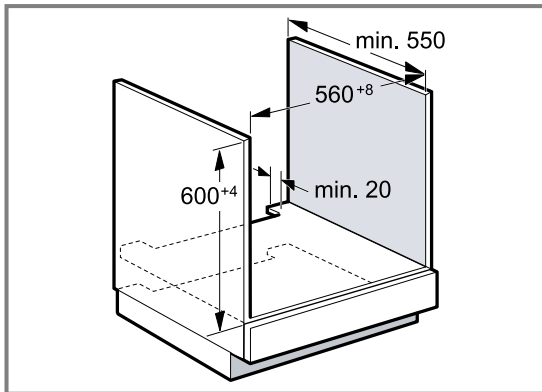

- To ventilate the appliance, the intermediate floor must have a ventilation cut-out.
- In combination with induction hobs, the gap between the worktop and appliance must not be sealed using additional strips.
- The worktop must be secured to the built-in unit.
- Observe any available installation instructions for the hob.

### 23.4 Installing below a hob

If the appliance is installed below a hob, the following minimum dimensions must be adhered to (including substructure, if applicable).

The minimum worktop thickness **b** is based on the required minimum clearance **a**.

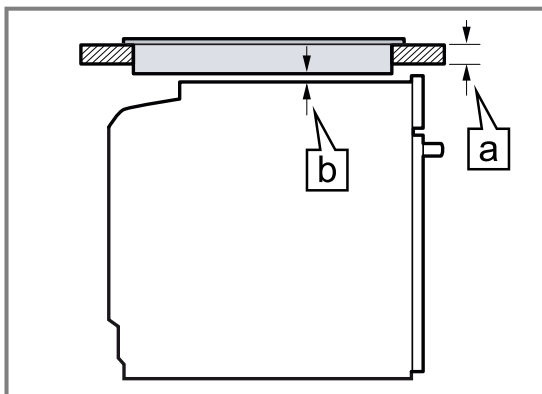

Hob type	a raised in mm	a flush in mm	b in mm
Induction hob	37	38	5
Full-surface induction hob	47	48	5
Gas hob	30	38	5
Electric hob	27	30	2

### 23.5 Installation in a tall unit

Observe the installation dimensions and the installation instructions when installing in a tall unit.

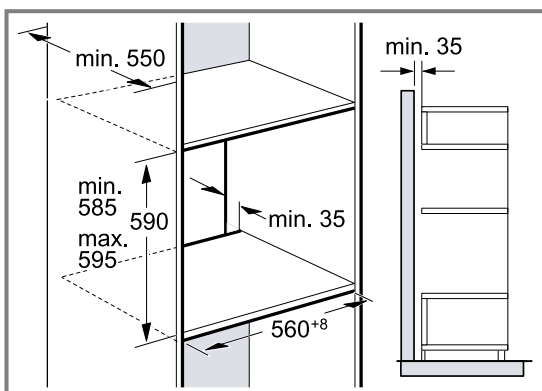

- To ventilate the appliance, the intermediate floors must have a ventilation cut-out.
- If the tall unit has another back panel in addition to the element back panels, this must be removed.
- Only fit the appliance up to a height which allows accessories to be easily removed.

## 23.6 Installing two appliances on top of each other

Your appliance can also be installed above or below another appliance. Observe the installation dimensions and the installation instructions when installing appliances on top of each other.

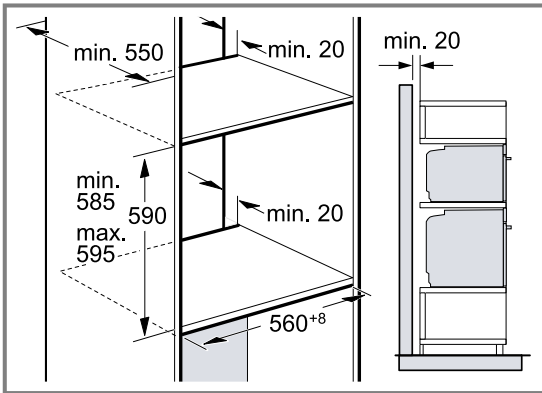

- To ventilate the appliances, the intermediate floor must have a ventilation cut-out.
- To ensure sufficient ventilation of the two appliances, there must be a ventilation opening of at least 200 cm<sup>2</sup> in the base area. To do this, trim the base panel or fit a ventilation grille.
- Ensure that air exchange is guaranteed in accordance with the diagram.

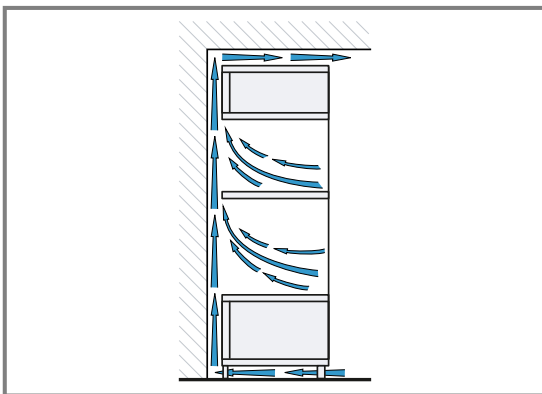

- Only fit appliances up to a height that allows accessories to be easily removed.

## 23.7 Corner installation

Observe the installation dimensions and the installation instructions when installing in a corner.

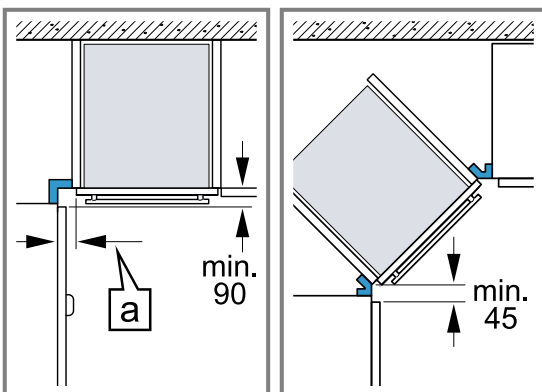

- To ensure that the appliance door can be opened, you must take the minimum dimensions into consideration when installing in a corner. The dimension a is dependent on the thickness of the unit front and the handle.

## 23.8 Electrical connection

In order to safely connect the appliance to the electrical system, follow these instructions.

- The appliance corresponds to protection class I and must only be operated with a protective earth connection.
- The fuse protection must correspond to the power rating specified on the appliance's rating plate and to local regulations.
- The appliance must be disconnected from the power supply whenever installation work is being carried out.
- Забороняється використання приладу в приміщеннях, де електрична мережа не обладнана заземлювальним проводом.
- The appliance must only be connected using the power cable provided.
- The power cable must be plugged in at the rear of the appliance until you hear a clicking sound. A 3 m power cable can be obtained from the after-sales service.
- The power cable must only be replaced with a cable from the original manufacturer. This is available from after-sales service.
- Contact protection must be guaranteed by the installation.

### Electrically connect the appliance with the protective contact plug

**Note:** The appliance must only be connected to a protective contact socket that has been correctly installed.

- ▶ Insert the plug into the protective contact socket. When the appliance is installed, the mains plug of the power cord must be freely accessible. If free access to the mains plug is impossible, an all-pole isolating switch must be integrated into the permanent electrical installation in accordance with the installation regulations.

### Electrically connecting an appliance without a protective contact plug

**Note:** Only a licensed professional may connect the appliance. Damage caused by incorrect connection is not covered under the warranty.

An all-pole isolating switch must be integrated into the permanent electrical installation according to the installation regulations.

1. Identify the phase and neutral conductors in the socket.  
The appliance may be damaged if it is not connected correctly.
2. Connect the hob in accordance with the connection diagram.  
See the rating plate for the voltage.
3. Connect the wires of the mains power cable according to the colour coding:
  - Green/yellow = Protective conductor (⊕)
  - Blue = Neutral conductor
  - Brown = Phase (external conductor)

### 23.9 Installing the appliance

**Note:** Do not use a cordless screwdriver to secure the panels. This may damage the panels.

1. If required, you can adjust the gap between the appliance door and the panels using the adjustment screws on the left and right.

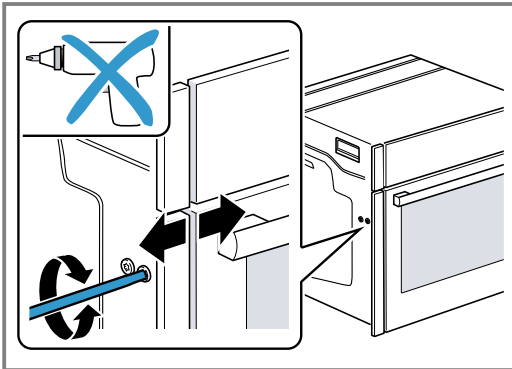

Turning the screws clockwise makes the gap larger  
Turning the screws anti-clockwise makes the gap smaller

2. Push the appliance in fully. Do not kink or trap the connection cable, or route it over sharp edges.
3. Centre the appliance.

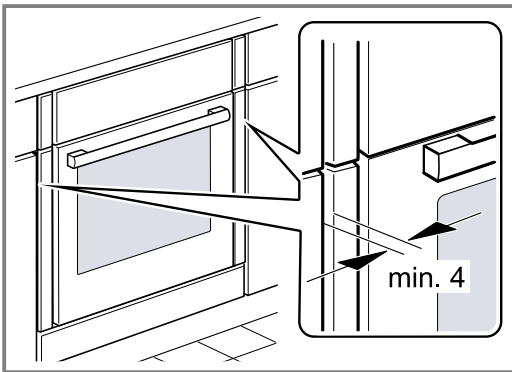

There must be an air gap of at least 4 mm between the appliance and adjacent unit fronts.

4. Open the appliance door slightly and unscrew panels on the left and right.

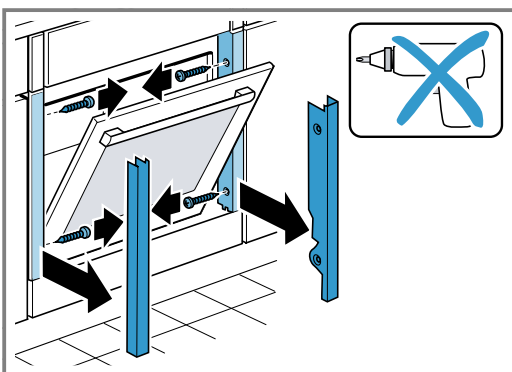

5. Close the appliance door.

6. If required, you can adjust the height of the appliance door using the adjustment screws on the left and right.

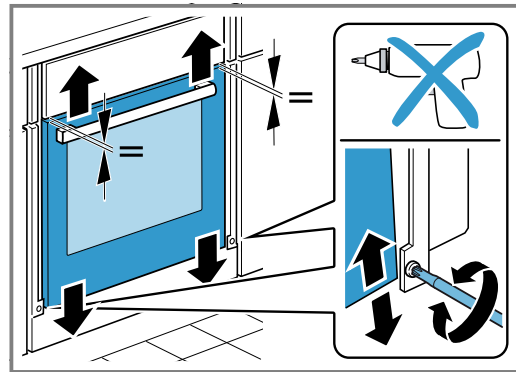

Turning the screws clockwise makes the gap smaller  
Turning the screws anti-clockwise makes the gap larger

7. Screw the appliance into place.

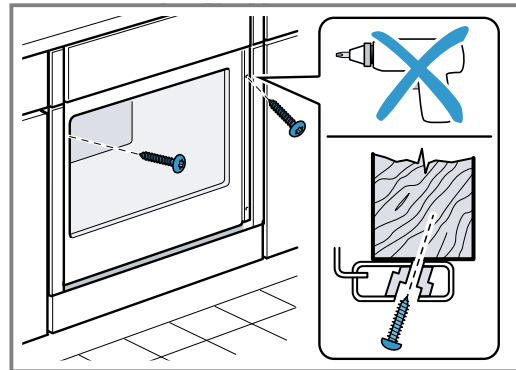

8. For handleless kitchens with vertical bar handle strips:
  - Attach a suitable filling piece ① in order to cover any sharp edges and to guarantee a safe installation.
  - Pre-drill aluminium profiles to establish a screw connection ②.
  - Secure the appliance using a suitable screw ③.

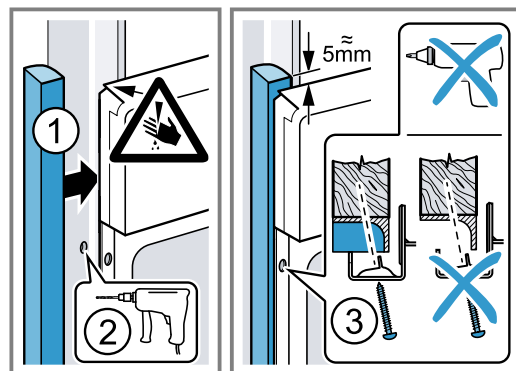

9. Open the appliance door slightly, then refit the panels and screw them in place, first at the top and then at the bottom.

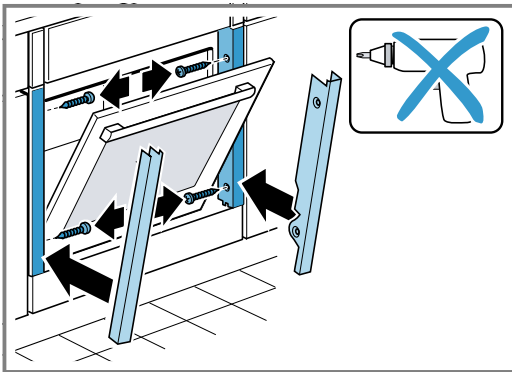

**Note:** The gap between the worktop and the appliance must not be closed by additional battens. Thermal insulation strips must not be fitted to the side panels of the surround unit.

### 23.10 Removing the appliance

1. Disconnect the appliance from the power supply.
2. Undo the fastening screws.
3. Lift the appliance slightly and pull it out completely.









Valid within Great Britain:  
Imported to Great Britain by  
BSH Home Appliances Ltd.  
Grand Union House  
Old Wolverton Road  
Wolverton, Milton Keynes  
MK12 5PT  
United Kingdom

REGISTER YOUR PRODUCT  
ONLINE [NEFF-HOME.COM](http://NEFF-HOME.COM)



Constructa-Neff Vertriebs-GmbH  
Carl-Wery-Straße 34  
81739 München  
GERMANY

9001629165  
010916  
en