



WASHER DRYER

en Instruction Manual and
Installation Instructions



Your new washer dryer

You have chosen a Neff washer dryer.

Please take a few minutes to read and become familiar with the advantages of your washer dryer.

To meet the high quality demands required by Neff, every washer dryer that leaves our factory is carefully checked to ensure that it functions correctly and is in perfect condition.

For more information on our products, accessories, replacement parts and services, see our website www.neff.de or contact our after-sales service centres.

If the operating and installation instructions describe different models, any differences will be pointed out at the relevant points in the text.



Read these operating and installation instructions before switching on the washer dryer.

Display rules

Warning!

This combination of symbol and signal word indicates a possibly dangerous situation. Not heeding the warning can cause death or injuries.

Caution!

This signal word indicates a possibly dangerous situation. Not heeding the caution can cause property and/or environmental damage.

Note/tip

Information about the optimum use of the appliance/any other useful information.

1. 2. 3. / a) b) c)

The steps are represented by numbers or letters.

■ / -

Lists are represented by a small box or a dash.

Contents

	Intended use	4
--	-------------------------------	----------

	Safety instructions	5
--	--------------------------------------	----------

	Children/people/pets	5
	Installation	6
	Operation	9
	Cleaning/Maintenance	11

	Environmental protection	13
--	---	-----------

	Packaging/used appliance	13
	Save energy and conserve resources	13

	Positioning and connecting	14
--	---	-----------

	Standard accessories	14
	Safety instructions	15
	Removing the transport locks	15
	Installation surface	16
	Installation on a base or a wooden joist floor	17
	Positioning and levelling	17
	Installing the appliance in a kitchenette	18
	Levelling	19
	Fitting the door hinges	19
	Hose and cable lengths	20
	Water inlet	21
	Water outlet	22
	Electrical connection	22
	Before washing for the first time	23
	Transportation	23

	Getting to know the appliance	24
--	--	-----------

	Appliance	24
	Control panel	25

	Laundry	30
--	--------------------------	-----------

	Preparing laundry for washing	30
	Preparing laundry for drying	31

	Detergents and care products	32
---	---	-----------

	Detergent recommendation	33
--	------------------------------------	----

	Overview of programmes	34
---	---	-----------

	Selectable programme *	34
	Drying table	36
	Starching	37
	Dyeing/bleaching	37

	Operating the appliance	37
---	--	-----------

	Preparing the appliance	37
	Select programme/switch on the appliance	38
	Placing laundry into the drum	38
	Dosing and adding detergent and care products	38
	Childproof lock	40
	Removing laundry/switching off the appliance	40

	Sensors	41
---	--------------------------	-----------





	Unbalanced load detection system	41
--	--	----

	Cleaning and maintenance	41
---	---	-----------

	Appliance housing/control panel	41
	Drum	41
	Descaling	42
	Detergent drawer and housing	42
	Drain pump is blocked	43
	The drain hose at the siphon is blocked	44
	Filter in the water supply is blocked	44

	Faults and what to do about them	45
---	---	-----------

	Emergency release	45
	Information on the display panel	45
	Faults and what to do about them	46

	Customer Service	49
	Product number (E-Nr.) and production number (FD)	49
	Consumption values	50
	Technical data	52
	Aqua-Stop warranty	52

Intended use

- This appliance is intended for private domestic use only.
- Do not install or operate this appliance anywhere that is liable to experience frost and/or outdoor conditions. There is a risk that the appliance will be damaged if residual water in it freezes. If hoses freeze up, they may crack/burst.
- This appliance must only be used for washing domestic laundry, consisting of machine-washable items and hand-washable woollens (see label on item). Using the appliance for any other purpose is outside of the scope of its intended application and is forbidden.
- This appliance must only be used for drying and freshening up domestic laundry, consisting of items that have been washed with water and are suitable for tumble drying (see label on item). Using the appliance for any other purpose is outside of the scope of its intended application and is forbidden.
- This appliance is suitable for operation with mains water and commercially available detergents and care products (must be suitable for use in washing machines).
- This appliance is intended for use up to a maximum height of 4000 metres above sea level.

Before you switch on the appliance:

Check that there is no visible damage to the appliance. Do not operate the appliance if it is damaged. Should you have any problems, please contact your specialist dealer or our customer service.

Read and follow the operating and installation instructions and all other information provided with this appliance.

Retain the documents for subsequent use or for subsequent owners.

Safety instructions

The following safety information and warnings are provided to protect you from injury and to prevent material damage to your surroundings.

It is nevertheless important to take the necessary precautions and to proceed with care when installing, maintaining, cleaning and operating the appliance.

Children/people/pets

Warning **Risk of death!**

Children and other people who are unable to assess the risks involved when using the appliance may injure themselves or may find themselves in life-threatening situations. Therefore please note:

- The appliance may be used by children over the age of 8 years and by persons with reduced physical, sensory or mental capacity or by persons with a lack of experience or knowledge as long as they are supervised or have received instruction on how to use the appliance safely and they have understood the potential risks of using the appliance.
- Children must not play with this appliance.

- Do not allow children to clean or maintain this appliance unsupervised.
- Keep children under 3 years and pets away from this appliance.
- Do not leave the appliance unattended when children or other people who are unable to assess the risks are in the vicinity.

Warning **Risk of death!**

Children may lock themselves inside appliances and find themselves in a life-threatening situation.

- Do not position the appliance behind a door, as this may obstruct the appliance door or prevent it from opening completely.
- Once an appliance has reached the end of its life, pull the mains plug from the socket **before** severing the mains cable, and then destroy the lock on the appliance door.

 **Warning**

Risk of suffocation!

If allowed to play with the packaging/plastic film or packing components, children may become caught in these or pull them over their heads and suffocate.

Keep packaging, plastic film and packing components away from children.

 **Warning**

Risk of poisoning!

Detergents and care products may result in poisoning if consumed.

If accidentally swallowed, seek medical advice. Keep detergents and care products out of the reach of children.

 **Warning**

Eye/skin irritation!

Contact with detergents or care products may cause eye/skin irritation.

Rinse eyes/skin thoroughly if they/it come(s) into contact with detergents or care products. Keep detergents and care products out of the reach of children.

Installation

 **Warning**

**Risk of electric shock/fire/
material damage/damage to
the appliance!**

If the appliance is not installed properly, this may lead to a dangerous situation. Ensure the following:

- The mains voltage on your power socket must match the rated voltage specified on the appliance (identification plate). The connected loads and the required fuse protection are specified on the identification plate.
- The appliance must not be supplied through an external switching device, such as a timer, or connected to a circuit that is regularly switched on and off by a utility.
- The mains plug and the protective contact socket must match and the earthing system must be correctly installed.
- The installation must have an adequate cross section.

- The mains plug must be freely accessible at all times. If this is not possible, in order to comply with the relevant safety regulations, a switch (all pole disconnection) must be built into the permanent installation in accordance with electrical installation regulations.
- If using a residual current circuit breaker, only use one that bears the following mark: . The presence of this mark is the only way to be sure that it fulfils all the applicable regulations.

Warning

Risk of electric shock/fire/material damage/damage to the appliance!

If the appliance's mains cable is altered or damaged, this may result in electric shock, short circuiting or fire due to overheating.

The mains cable must not be kinked, crushed or altered, and must not come into contact with any heat sources.

Warning

Risk of fire/material damage/damage to the appliance!

The use of extension cords or power strips may result in fire due to overheating or short circuiting.

Connect the appliance directly to an earthed socket that has been correctly installed. Do not use extension cords, power strips or multi-way couplers.

Warning

Risk of injury/material damage/damage to the appliance!

- The appliance may vibrate or move when in operation, potentially resulting in injury or material damage. Place the appliance on a clean, even, solid surface and, using a spirit level to guide you, level it with the screw-in feet.
- If you take hold of any of the appliance's protruding parts (e.g. the appliance door) in order to lift or move it, these parts may break off and cause injury. Do not take hold of any of the appliance's protruding parts in order to move the appliance.



Warning

Risk of injury!

- The appliance is very heavy. Lifting it may result in injury. Do not lift the appliance on your own.
- The appliance has sharp edges on which you could cut your hands. Do not take hold of the appliance by its sharp edges. Wear protective gloves to lift it.
- If the hoses and mains cables are not correctly routed, they may constitute a tripping hazard, which may result in injury. Route hoses and cables such that they do not constitute a tripping hazard.

Caution!

Material damage/damage to the appliance

- If the water pressure is too high or too low, the appliance may not be able to operate properly, and it may also result in material damage or damage to the appliance. Make sure that the water pressure in the water supply facility is at least 50 kPa (0,5 bar), and does not exceed 900 kPa (9 bar).
- If the water hoses are altered or damaged, this may result in material damage or damage to the appliance. The water hoses must not be kinked, crushed, altered or severed.
- The use of hoses supplied by other brands to connect to the water supply may result in material damage or damage to the appliance. Use the hoses supplied with the appliance or genuine spare part hoses only.

- The appliance is secured for transportation by transport locking devices. If the transport locking devices are not removed before the appliance is operated, this may result in damage to the appliance.

It is important to completely remove all transport locking devices before using the appliance for the first time. Make sure that you retain these transport locking devices separately. It is important to refit the transport locking devices if the appliance is to be transported, in order to prevent the appliance from being damaged in transit.

Operation

Warning

Risk of explosions/fire!

Laundry that has come into contact with solvents, oil, wax, wax remover, paint, grease or stain remover may ignite when dried in the machine, or even cause the appliance to explode. Therefore please note:

- Rinse the laundry thoroughly with warm water and detergent before drying it in the machine.

- Do not place laundry in this appliance to be dried if the laundry has not been washed first.
- Do not use the appliance if industrial chemicals have been used to clean the laundry.

Warning

Risk of explosions/fire!

- Laundry that has been pretreated with cleaning agents that contain solvents, e.g. stain remover/cleaning solvent, may cause an explosion in the drum. Rinse the laundry thoroughly with water before washing it in the machine.
- Certain objects may ignite when drying is in progress, or even cause the appliance to catch fire or explode. Remove any lighters or matches from pockets on items of clothing.
- If there is coal dust or flour in the air around the appliance, this may cause an explosion. Make sure that the area around the appliance is kept clean when it is in operation.

 **Warning**

**Risk of fire/material damage/
damage to the appliance!**

If a program is terminated before the drying cycle has finished, this prevents the laundry from cooling down sufficiently and may cause the laundry to ignite, or may result in material damage or damage to the appliance.

- During the last part of the drying cycle, the laundry in the drum is not heated (cooling cycle). This is to ensure that it remains at a temperature at which it will not be damaged.
- Do not switch off the appliance before the drying cycle has finished unless you remove all items of laundry from the drum immediately and spread them out (to dissipate the heat).

 **Warning**

Risk of poisoning!

Poisonous fumes may be given off by cleaning agents that contain solvents, e.g. cleaning solvent.

Do not use cleaning agents that contain solvents.

 **Warning**

Risk of injury!

- If you support your weight/sit on the appliance door when it is open, the appliance may tip over, which may result in injury.

Do not support your weight on the appliance door when it is open.

- If you climb onto the appliance, the worktop may break, which may result in injury.

Do not climb onto the appliance.

- If you reach into the drum while it is still rotating, you risk injuring your hands. Wait until the drum has stopped rotating.

 **Warning**

Risk of scalding!

When washing at high temperatures, there is a risk of scalding if you come into contact with hot detergent solution (e.g. when draining hot detergent solution into a washbasin).

Do not reach into the hot detergent solution.

⚠ Warning**Eye/skin irritation!**

Detergent and care products may spray out if the detergent drawer is opened while the appliance is in operation. Rinse eyes/skin thoroughly if they/it come(s) into contact with detergents or care products. If accidentally swallowed, seek medical advice.

Caution!**Material damage/damage to the appliance**

- If the amount of laundry in the appliance exceeds its maximum load capacity, it may not be able to operate properly, or this may result in material damage or damage to the appliance. Do not exceed the maximum load capacity of dry laundry. Make sure you comply with the maximum load capacities specified for each of the programs.
- Foam and foam rubber may deform or melt if dried in the appliance. Do not dry laundry items that contain foam or foam rubber in the appliance.

- If you pour the wrong quantity of detergent or cleaning agent into the appliance, this may result in material damage or damage to the appliance. Use detergents/care products/cleaning agents and softeners in accordance with the manufacturers' instructions.

Cleaning/Maintenance**⚠ Warning****Risk of death!**

The appliance is powered by electricity. There is a risk of electric shock if you come into contact with live components. Therefore please note:

- Switch off the appliance. Disconnect the appliance from the power supply (pull out the plug).
- Never take hold of the mains plug with wet hands.
- When removing the mains plug from the socket, always take hold of the plug itself and never the mains cable, otherwise this may damage the mains cable.
- Do not make any technical modifications to the appliance or its features.

- Repairs and any other work on the appliance must only be conducted by our customer service or by an electrician. The same applies for replacing the mains cable (when necessary).
- Spare mains cables can be ordered from our customer service.

⚠ Warning
Risk of poisoning!

Poisonous fumes may be given off by cleaning agents that contain solvents, e.g. cleaning solvent.

Do not use cleaning agents that contain solvents.

⚠ Warning
Risk of electric shock/material damage/damage to the appliance!

If moisture penetrates the appliance, this may cause it to short circuit.

Do not use a pressure washer, steam cleaner, hose or spray gun to clean your appliance.

⚠ Warning
Risk of injury/material damage/damage to the appliance!

The use of spare parts and accessories supplied by other brands is dangerous and may result in injury, material damage or damage to the appliance. For safety reasons, use genuine spare parts and accessories only.

Caution!
Material damage/damage to the appliance

Cleaning agents and agents for pretreating laundry (e.g. stain removers, prewash sprays, etc.) may cause damage if they come into contact with the surfaces of the appliance. Therefore please note:

- Do not allow these agents to come into contact with the surfaces of the appliance.
- Clean the appliance with nothing but water and a soft, damp cloth.
- Remove any detergent, spray or other residues immediately.



Environmental protection

Packaging/used appliance



Dispose of packaging in an environmentally-responsible manner.

This appliance is labelled in accordance with European Directive 2012/19/EU concerning used electrical and electronic appliances (waste electrical and electronic equipment - WEEE).

The guideline determines the framework for the return and recycling of used appliances as applicable throughout the EU.

Save energy and conserve resources

If you follow these instructions, your appliance will use less electricity and less water.

Choose programmes with low temperatures and longer wash times and use maximum load capacity
→ *Page 34*.

- Energy consumption and water consumption is most efficient.

Use the economy programme settings.

- If you adjust the programme settings for a programme, the display shows the expected consumption.

Add → *Page 33* detergent based on the laundry's degree of soiling.

- For light to normal soiling, a smaller amount of detergent is sufficient. Observe the dosage recommendation from the detergent manufacturer.

Reduce the washing temperature for lightly and normally soiled laundry.

- At low temperatures, the appliance consumes less energy. For light to normal soiling, lower temperatures than indicated on the care label are also sufficient.

Set the maximum spin speed if you want to dry the laundry in a tumble dryer afterwards.

- The drier the laundry, the shorter the programme duration when drying which, in turn, reduces energy consumption. A higher spin speed reduces the residual moisture in the laundry and increases the volume of the spin noise.

Wash the laundry without prewash.

- Washing with prewash increases the programme duration and increases energy and water consumption.

The appliance has a continuous automatic load adjustment function.

- Depending on the type of fabric and load capacity, the continuous automatic load adjustment function optimally adjusts the water consumption and programme duration.



Positioning and connecting

Standard accessories

Note: Check the appliance for transport damage. Never use a damaged appliance. If you have any complaints, contact the dealer from whom you purchased the appliance or our Customer Service.

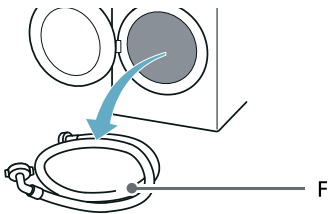
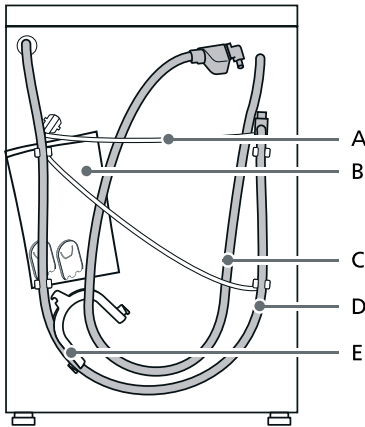

A Mains lead

- B Bag*:
 - Installation and operating instructions
 - Customer Service location directory*
 - Warranty*
 - Supplementary sheet for the installation and operating instructions*
 - Cover caps for openings after the transport braces have been removed
- C Water inlet hose on aquaStop models
- D Water outlet hose
- E* Ellbow to securing the water outlet hose
- F Cold water inlet hose on Standard/Aqua-Secure models
- * Depending on the model

Included with the appliance

Num	Description
ber	
5	Covers for openings left after removing the transport bolts.
1	Spanner
1	24-40 mm dia. hose clamp for connection to a siphon
1	Door template
2	Door hinges with screws

Useful tool

- Wrench for loosening the transport bolts and aligning the appliance feet
- Wrench with:
 - WAF13 for loosening the transport braces and
 - WAF17 for aligning the appliance feet

Safety instructions

Warning **Risk of injury!**

- The appliance is very heavy. Be careful when lifting/transporting the appliance.
- When the appliance is lifted by its protruding parts (e.g. the appliance door), the components may break off and cause injuries. Do not lift the appliance by protruding parts.
- If the hose and mains cables are not routed properly, there is a risk of tripping and injury. Lay hoses and cables in such a way that there is no risk of tripping.

Caution!

Damage to the appliance

Frozen hoses may rip/burst. Do not install the appliance in areas exposed to frost or outdoors.

Caution!

Water damage

The connection points for the water supply hose and water drain hose are under high water pressure. To prevent leaks and water damage, you must follow the instructions in this section.

Notes

- In addition to the safety information listed here, the local water and electricity supplier may have special requirements.
- If in doubt, have the appliance connected by a specialist.

Removing the transport locks

Caution!

Damage to the appliance

- The appliance is secured for transportation using transport locks. If the transport locks are not removed, the appliance may become damaged when it is operated.
- To prevent transport damage from occurring if the appliance is moved at a later date, you must refit the transport locks before transporting the appliance.

Note: Keep the screws and sleeves in a safe place.



en Positioning and connecting

1. Unscrew all screws using the spanner supplied.

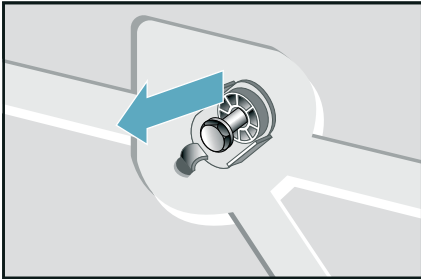

- Remove all transport safety bolts completely

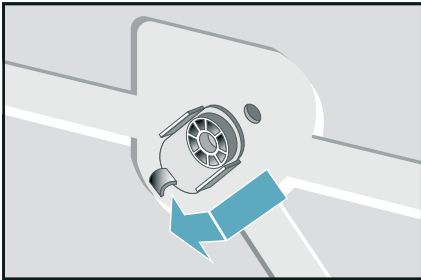

- take the mains cable out of the retainers

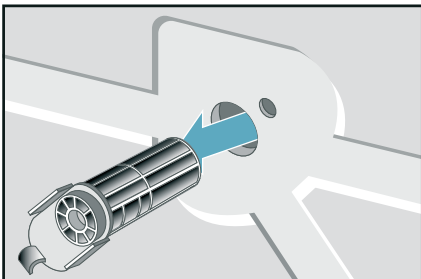

2. Insert the protective covers..

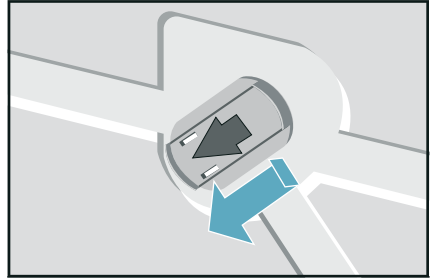

Notes

- Before using the appliance for the first time, make sure that all transport safety bolts have been removed and kept safe for any subsequent transport.
- If you need to transport the appliance at a later date, always refit the transport safety bolts to prevent damage to the washer dryer.

Installation surface

- Note:** The appliance must be stable aligned so that it does not move around.
- The installation surface must be firm and level.
 - Soft floors/floor coverings are not suitable.

Installation on a base or a wooden joist floor

Caution!

Damage to the appliance

The appliance may damage to the appliance and kitchen furniture when spinning.

Note: On wooden joist floors, install the appliance:

- The feet of the appliance must be secured,
- On a water-resistant wooden board (min. 30 mm thick) which is screwed tightly to the floor.

Positioning and levelling

Caution!

Appliance stability is essential to ensure that the washer-dryer does not “creep” during spin cycles.

The installation area must be firm, clean and level.

Parquet floors and soft floor coverings, e.g. carpets or foam-backed floor coverings, are unsuitable.

Installing the appliance in a kitchenette

Warning **Risk of death!**

There is a risk of electric shock if you touch live components.
Do not remove the appliance covering plate.

Notes

- Recess width of 60 cm required.
- Only install the appliance underneath a continuous worktop that is securely connected to adjacent cabinets

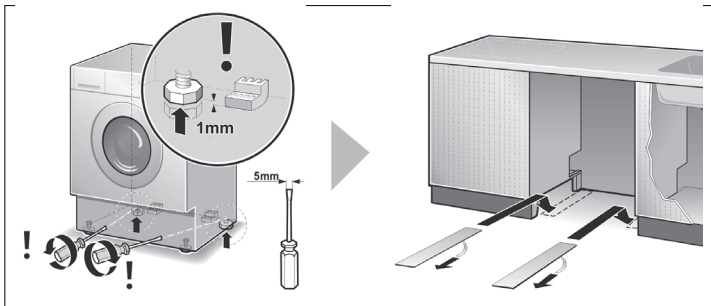

Slide sheets make it easier to slide the washing machine into the installation recess.

Notes

- Can be ordered from the after-sales service, spare part no. 66 1827.
- Moisten the slide sheets with a mixture of water and washing-up liquid before sliding the washer-dryer into place. Do not use grease and/or oil.

Levelling

Caution!

Intense noise, vibrations and wandering may be the result of incorrect levelling.

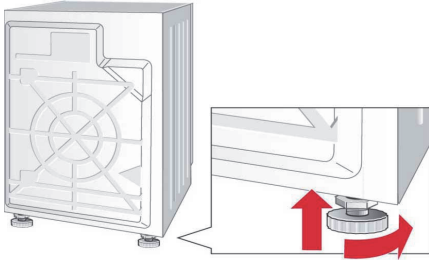

Notes

- All four appliance feet must stand firmly on the ground.
- The washer-dryer must not wobble.
- Check the levelness of the washer-dryer with a spirit level and correct if necessary.
- The washer-dryer must not rest against the sides of the installation recess.
- The lock nuts of the front appliance feet must be screwed tightly against the housing.

Fitting the door hinges

Caution!

Once the washer-dryer has been installed in a kitchen unit, it can be concealed with a door. Hinges supplied to the washer-dryer must be fitted.

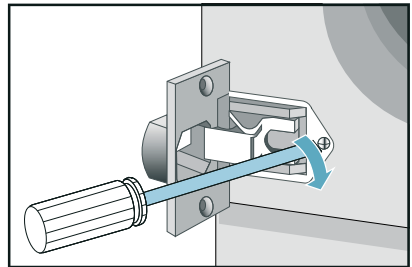
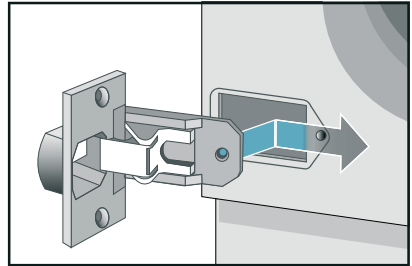

Hose and cable lengths

Connection on left side or connection on right side

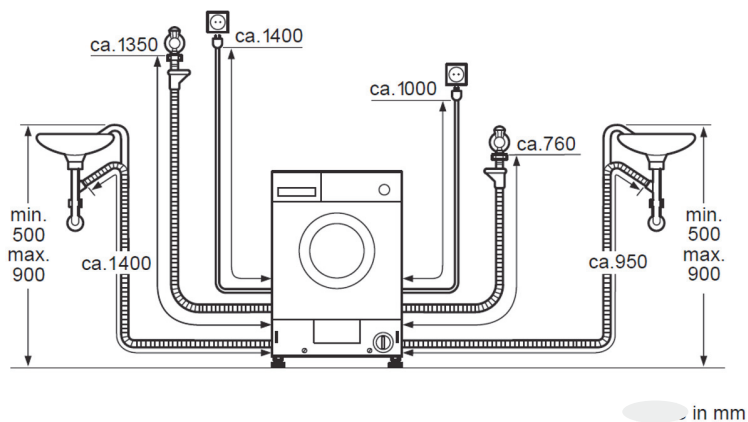

Note:

If the supply hose is too short for your connection, you can order an extension from the after-sales service.

Water inlet

Warning **Risk of death!**

There is a risk of electric shock if you touch live components.
Do not immerse the Aqua-Stop safety valve* in water (it contains an electric valve).

* Depending on the model

Observe the following when connecting the appliance:

Notes

- Only operate the appliance using cold mains water.
- Do not connect the appliance to the mixer tap of an unpressurised hot-water boiler.
- Do not use a used supply hose. Only use the supply hose supplied or one that was purchased from an authorised specialist retailer.
- Do not bend, squash, modify or cut through the water supply hose (otherwise its strength is no longer guaranteed).
- Only tighten the screw connections by hand. If the screw connections are tightened too much with a tool (pliers), the thread may be damaged.

Optimum water pressure in the supply network

At least 50 kPa (0,5 bar)

Maximum 900 kPa (9 bar)

When the tap is open, the water flow is at least 8 l/min.

If the water pressure is higher than this, a pressure-reducing valve must be installed.

Caution! **Water damage**

When water is being pumped away, the outlet hose is under water pressure and may slip out of the wash basin or connection point. Secure the drain hose so that it cannot slip out.

Connection

1. Connect the water supply hose to the water tap ($\frac{3}{4}$ " = 26.4 mm) and to the appliance (*depending on the model):
 - Model: **Standard***

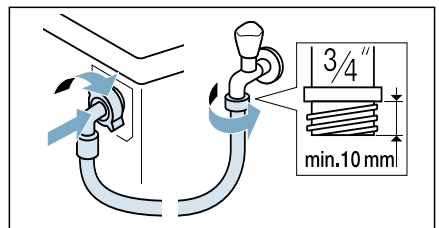

- Model: **Aqua-Secure***

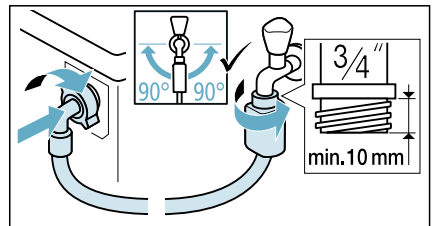

en Positioning and connecting

- Model: **Aqua-Stop***

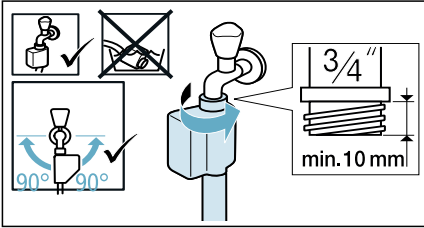

Tip: Connect also an external water filter (depending on the model) between water supply hose and tap. The filter filters dirt particles out of the water. Water filter must be cleaned regularly to remove contaminants. This will prevent blockages. See also → separate installation and cleaning instruction for water filter.

2. Open the water tap carefully, checking the leak tightness of the connection points. The screw connection is under mains water pressure.

Water outlet



Warning **Risk of scalding!**

When you are washing at high temperatures, there is a risk of scalding if you come into contact with hot water (e.g. when draining hot water into a washbasin). Do not reach into the hot water.

Caution!

Damage to the appliance/fabrics

If the end of the drain hose is immersed in the drained water, water may be sucked back into the appliance and may damage the appliance/fabrics. Make sure that:

- The end of the drain hose is not immersed in the drained water.

- The water drains away quickly enough.

Note: Do not kink the water drain hose or put strain on it lengthways.

Connection

■ **Drainage into a siphon**

The connection point must be secured using a hose clamp with a diameter of 24 - 40 mm (inside accessory).

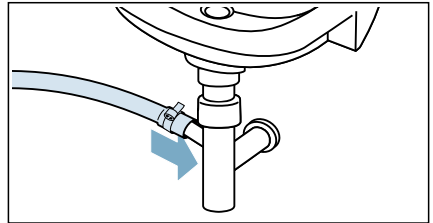

Electrical connection



Warning **Risk of death!**

There is a risk of electric shock if you touch live components.

- Never touch or hold the mains plug with wet hands.
- Only pull out the mains cable by the plug and never by the cable, as this could damage it.

Observe the following information and ensure that:

Notes

- The mains voltage and voltage indicated on the appliance (rating plate) are the same. The connected load and fuse required are specified on the rating plate.
- The appliance is only connected to an alternating current via a properly installed earthed socket.
- The mains plug fits the socket.

- The earthing system is properly installed.
- The mains cable is only replaced by a qualified electrician (if this is necessary). Replacement mains cables are available from the after-sales service.
- No multiple plugs/couplings or extension cables are used.
- If an earth-leakage circuit breaker is used, only a type which displays this symbol is used: . Only this symbol guarantees compliance with the currently applicable regulations.
- The mains plug can be accessed at all times.
- The mains cable is not bent, squashed, modified, cut through, or in contact with heat sources.

Before washing for the first time

The appliance was inspected thoroughly before leaving the factory. To remove any residual test water, run Cottons 60°C programme the first time without laundry.

Note:

- The appliance must have been installed and connected properly. → "Positioning and connecting" on page 14
 - Never switch on a damaged appliance.
1. Insert mains plug.
 2. Turn the water tap on.
 3. Close the door. Do not load any laundry.
 4. Select the Cottons 60°C programme.
 5. Open the detergent drawer.

6. Add standard detergent to dispenser **II** according to manufacturer's instructions for light soiling.
Note: To prevent over sudsing, use only half the recommended amount of detergent. Do not use any woollens or mild detergents.
7. Close the detergent drawer.
8. Select ▷||| (Start/Pause).
9. When the programme ends, turn the dial to the Off position and open the door.

Your appliance is now ready for use.

Transportation

e.g. when moving home

Preparatory work:

1. Turn off the water tap.
2. Reduce the water pressure in the supply hose. → Page 44
3. Drain any residual water.
→ Page 43
4. Disconnect the appliance from the mains.
5. Remove the hoses.
6. Empty the dispensers.
→ "Detergent drawer and housing" on page 42

Installing the transport locks:

1. Remove the covers and keep them in a safe place.
Note: Use a screwdriver if necessary.
2. Insert all four sleeves.
 - a) Clip the mains cable securely in the holders.
 - b) Insert and tighten the screws.
 - c) Clip the hoses securely in the holders.

Before switching on the appliance again:

Note: The transport bolts must be removed.

Getting to know the appliance

Appliance

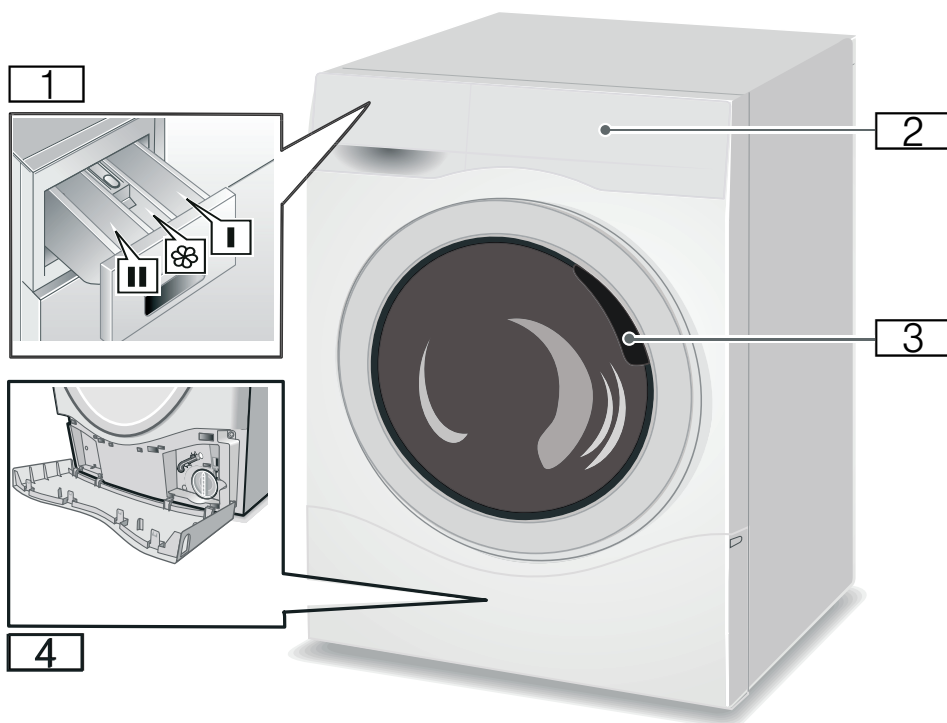

- 1 Detergent drawer
- 2 Operating/display panel
- 3 Loading door
- 4 Service flap

Control panel

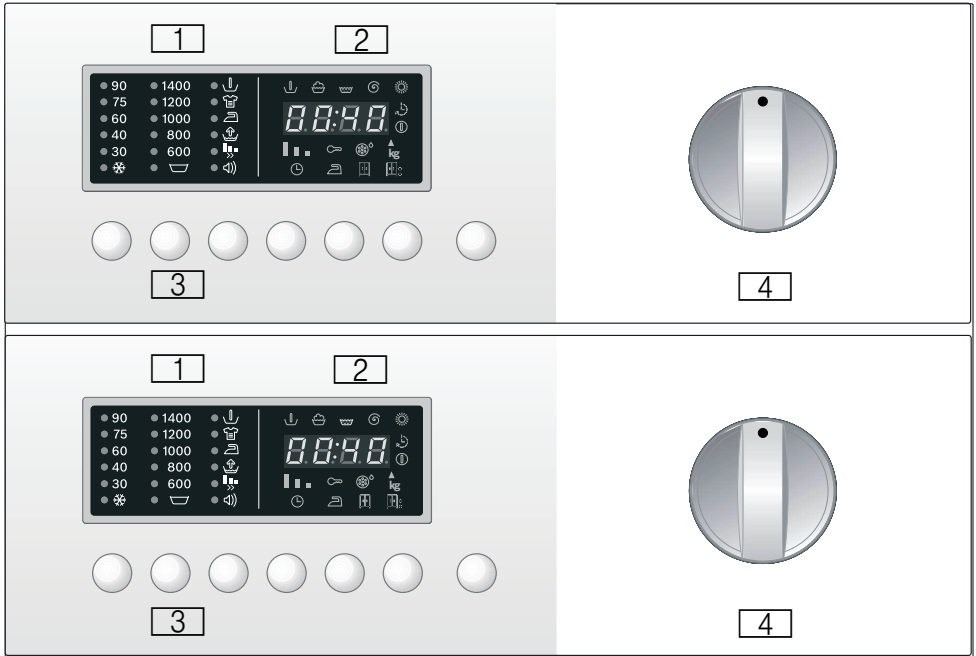

1 Indicator lamp*
Indicates the settings that have been selected for:



- Temperature ❄ 90°C
- Spin speed 1400 rpm.
- Options/signal

2 Display Panel*
Shows the settings that have been selected (e.g. spin speed, drying time), the progress of the current programme and the programme status.

- Programme progress:
 - ⏴ (Prewash)
 - 🧺 (Main Wash)
 - 🧺 (Rinse)
 - ⌚ (Final Spin)
 - (Drying) ❄
- Drying options:
 - ⌚ (Time-controlled drying)
 - 🧺 (Iron-damp)
 - 🧺 (Cupboard dry)
 - 🧺* (Extra-dry)
- Auxiliary displays:
 - ⌚ (programme start)
 - 🔒 (Childproof lock)
 - ❄* (Fluff removal cycle)
 - kg (reccomended load)

en Getting to know the appliance

3 Buttons*

- Temperature  °C: individual adjustment of the washing temperature.
- Spin speed : individual adjustment of the spin speed.
- Options: sets washing options.
- Set: activation/deactivation of the selected washing options.
- Finished In delays the Programme start.
- Drying  : sets the drying options





Start/Pause  starts and stops the washing programme.

4 Programme selector*

For switching the washer-dryer on and off and for selecting the programme, can be turned in both directions. Do not adjust the programme selector while washing/drying is in progress.





* Depending on the model.

Options



Option	Description
 (Prewash)	Prewash at 35 °C. Suitable for heavily soiled laundry.
Spin speed	The spin speed can be individually adjusted for each programme. To set the spin speed, press the B (Spin) button repeatedly until the required spin speed is displayed.
Rinse hold 	Deactivates the spin function. The laundry remains in the rinsing water.
Intensive	Prolonged washing time. Suitable for particularly heavily soiled laundry with dried-on stains. Cannot be combined with Flexi Time
Easy-iron 	Special spin sequence with subsequent fluffing. Gentle final spin at reduced speed. Slightly increased residual moisture in the laundry. Reduces creasing and laundry is easier to iron.
Water plus 	Increased water level and additional rinse cycle. For regions with very soft water or for further improving the rinsing result. Any detergent residues are removed.
Flexi Time	Sets the washing time. normal-medium-short.

Option	Description
Signal 	Activates or deactivates the audible signal.
Finished In	You can postpone Programme start before it begins. Using the Remaining time, you can determine when the selected programme is to end. The remaining time can be set in one-hour increments, up to a maximum of 24 hours. Press the 0 (Finished in) button repeatedly until the required number of hours is displayed. Then press the A (Start/Pause) button, the programme will start after a delay according to the set Remaining time. The required time to the end of the programme is shown on the display panel..



Drying options

Option	Description
Drying Button	The drying programmes can be individually adapted by selecting the drying options. – Press the Drying button repeatedly until the required drying option is shown on the display panel. – To deactivate, press the Drying button repeatedly until 00:00 is shown on the display.
 (Time-controlled drying)	The drying time can be set to between 2:40 and 0:00 by repeatedly pressing the Drying button.
 (Iron-damp)	The residual moisture in the washing is increased. Enables easier ironing..
 (Cupboard dry)	The laundry is dry and ready to put away
 * (Extra-dry)	The laundry is dried intensively. Suitable for laundry that is hard to dry.
The laundry is dry and ready to put away	The laundry is dried intensively. Suitable for laundry that is hard to dry.



Washing only

- Turn the programme selector to the desired programme, e.g. Cottons 60°C
 - The display panel alternately shows Remaining time and the recommended load in kg
- If necessary, adjust the temperature and the spin speed and select any options for your individualised programme.
 - The  (Drying) function must not be activated.
- Load the laundry.
 - Observe the maximum load.
 - Programme table.
- Press the Start/Pause 
 - Remaining time is shown on the display panel
 - The washing programme starts.

Drying only

- Turn the programme selector to the desired drying programme
 - The display panel alternately shows Remaining time and the recommended load in kg.
- Press the  (Drying) button to set the drying options.
 - If you do not make a selection, the  (Cupboard dry) option is set.
- Load the laundry.
 - Observe the maximum load.
 - Programme table.

Washing and drying

- Turn the programme selector to the desired programme, e.g. Cottons 60°C
 - The display panel alternately shows ☉ (Remaining time) and the commended load and the kg
- If necessary, adjust the temperature and the spin speed and select any options for your individualised programme.
- Press the  (Drying) button to set the drying options.
- Load the laundry.
 - Observe the maximum load.
 - Programme table.
- Press the Start/Pause 

The drying programme that is carried out is automatically determined by the washing programme, see the Programme table.

Changing the programme

To change the programme:

- Select a new programme.
- Press the Start/Pause  button.

The new programme starts.



End of the programme

- The washing and drying programmes are ended automatically. **End** appears on the display panel.
 - Turn the programme selector to Off.
 - Remove the washing from the drum.
 - Leave the door open to allow the inside of the washer-dryer to dry out.
 - Turn off the tap (not necessary on models with Aqua-Stop).



Cancelling the programme

Press and hold button Start/Pause  until **00:00** is displayed.

For washing programmes at high temperatures:

- Cooling down laundry: choose  +  + Spin
- Press the Start/Pause  button.

For programmes at low temperatures:

- Choose  +  + Spin
- Press the Start/Pause  button.

If you cancel the Drying programme, the laundry may still be very hot.

Rinse hold

- If the spin function was deactivated at the start of the wash cycle, the washing programme is automatically stopped after the final rinse. The display panel shows **STOP** alternating with **-:-**. In order to drain the rinsing water and, if required, spin the laundry:

- Press the Spin repeatedly until the required spin speed is set. The water is Drained and the washer-dryer spins the laundry. The programme is completed when **End** appears in the display field.
- The maximum spin speed depends on the selected wash programme.

If you do not wish to spin the laundry:

- Press the Spin button (remaining time for Draining is displayed). The water is Drained, but the washer-dryer does not spin the laundry. The programme is complete when **End** appears on the display panel.
- Set the programme selector to Off
- Remove the laundry.
- Leave the door open to allow the inside of the washer-dryer to dry out.
- Turn off the tap (not necessary on models with Aqua-Stop).



Laundry

Preparing laundry for washing

Protecting your laundry and appliance

Caution!

Damage to the appliance/textiles

Foreign objects (e.g. coins, paper clips, needles, nails) may damage the washing or components of the appliance.

The following instructions must be observed when preparing your laundry:







- Always follow the manufacturer's instructions when dosing all detergents, cleaning aids, care products and cleaning agents.
- Do not exceed maximum load. Overfilling will impair the washing result.
- Keep detergents and agents for the pretreatment of laundry (e.g. stain remover, prewash sprays, etc.) away from the surfaces of the appliance. Using a damp cloth, immediately remove any fine spray residue and other residue or droplets.
- Empty any pockets. Remove any foreign objects.
- Remove metal parts (paper clips, etc.).
- Trousers, knitwear and knitted textiles, e.g. jersey garments, T-shirts or sweatshirts, should be turned inside out.
- Ensure that underwired bras are appliance-washable.
- Wash delicates in a net or bag (tights, underwired bras, etc).
- Close zips, button up covers.
- Brush sand out of pockets and collars.
- Remove curtain fittings or place in a net/bag.

Note: The higher spinning speed in the spinning phase, the higher the noise and the lower remaining moisture content

Sorting laundry

Sort your laundry according to the care instructions and manufacturer's information on the care labels, depending on:

- Type of fabric/fibre
- Colour
- **Note:** Laundry may discolour. Wash white and coloured items separately. Wash new coloured items separately the first time you wash them.
- Soiling
 - Wash laundry with the same level of soiling together.
 - Some examples of soiling levels can be found in the chapter
 - **Light:** Do not need to pretreat.
 - **Normal:** Soiled laundry.
 - **Heavy:** Load less laundry, need to pretreat or soak laundry firstly.
 - **Stains:** Remove/pretreat stains while they are fresh. First dab with soapy water; do not rub. Then wash the items of laundry with the appropriate programme. Stubborn or dried-in stains can sometimes only be removed by washing several times.
- Symbols on the care labels



-  Suitable for normal washing process; e.g. Cottons programme
-  A gentle washing process is required; e.g. Easy Care programme
-  An especially gentle washing process is required; e.g. Delicates/Silk programme
-  Suitable for washing by hand; e.g.  Wool programme
-  Do not machine wash.

Preparing laundry for drying

Note: To ensure an even drying result, sort the laundry according to the:

- Type of fabric
- Care symbols which are indicated on the care labels.

Only dry laundry which is labelled “dryer-proof” or which has the following care symbols:

-  : Dry at normal temperature
-  : Dry at low temperature (delicate drying)

The following textiles should not be dried:

-  = care symbol “Do not dry”
- Delicates (silk, synthetic curtains).
- Textiles which contain foam rubber or similar materials.
- Textiles which were treated with flammable liquids, e.g. with stain remover, petroleum ether, thinners. Risk of explosion!
- Textiles which still contain hairspray or similar substances.

Notes

- Before drying, hand-washed textiles must be spun at the appropriate spin speed.
- Before drying, spin at the optimum speed. A spin speed of more than 1000 rpm is recommended for cotton, more than 800 rpm for easy-care textiles.
- Do not iron washing immediately after drying. It is recommended to roll the washing up first to distribute residual moisture evenly.
- To ensure a good drying performance, quilts, terry cloths and other large textiles should be dried separately. Do not dry more than 6 terry cloths (or 4 kg).
- Do not exceed the maximum load.



Detergents and care products

You can protect your appliance and your laundry by selecting and using the correct detergents and care products. You can use all detergents and care products which are suitable for your appliance.

Note: Please read the safety information → *Page 5* to ensure that you use the appliance safely.

The manufacturer's instructions for use and dosage can be found on the packaging.

Notes

- Only use liquid detergents that are self-flowing
- Do not mix different liquid detergents
- Do not mix detergent and fabric softener
- Do not use products which have developed a top layer or are highly congealed
- Do not use products containing solvents, caustic agents or volatile substances (e.g. bleach)
- Use dyes sparingly as salt may damage stainless steel
- Do not use bleaching agents in the appliance

Detergent recommendation

This information is intended to help you to choose the right detergent for your items.

Fabrics	Detergent	Programme	Temperature
Heat-resistant white fabrics made from cotton or linen	Standard detergent with optical brighteners	Cottons	From cold up to 90 °C
Coloured fabrics made from linen or cotton	Detergent for colours without bleach or optical brighteners	Cottons	From cold up to 60 °C
Coloured fabrics made from easy-care fabrics or synthetic materials	Detergent for colours/delicates without optical brighteners	Easy Care	From cold up to 60 °C
Delicate fabrics made from silk or viscose	Delicates	Delicates/Silk	From cold up to 40 °C
Wool	Detergent for Woollens	Wool	From cold up to 40 °C

Tip:

Visit www.cleanright.eu to find further information on detergents, care products and cleaning agents for domestic use.

Overview of programmes

Selectable programme *

Washing Programmes*
Name of the programme
Brief explanation of the programme and for which fabrics it is suitable
Cottons
Suitable for hard-wearing fabrics, heat-resistant fabrics made from cotton or linen. – Coloureds up to 60 °C. – Whites 60 °C to 90 °C
Eco 40-60
Washing programme for the best possible washing result with minimum energy and water consumption. Wash items made from cotton, linen or blended fabrics. Suitable for washing normally soiled cotton textiles, and drying it to be immediately stored in a cupboard.
Wash and dry programme can be achieved by selecting Eco 40-60 programme and activating (wash&dry) .
Easy Care
Washing programme for less hard-wearing fabrics made from cotton, linen, synthetic fibres or blended fabrics. It is advisable to sort the laundry by colour.
Delicates/Silk
Gentle programme for delicate, washable fabrics, e.g. silk, satin, synthetics or blended fabrics (e.g. curtains). Gentle spinning between the rinse cycles and reduced final spin speed.
 Wool
Wool becomes matted when subjected to heat, moisture and movement.
The woollens programme takes these qualities into account and finds a compromise between standing still and movement. Suitable for hand- or machine-washable fabrics made from wool or a woolblend.
Note: In order to prevent clothing shrink, after drying still contain a small amount of water, please take out the clothes as soon as possible after the end of the programme to flat dry.
Super Quick 15' (Rapid 15)
Short programme for easy-care, lightly soiled fabrics made from cotton, linen, synthetics or blends. Suitable for freshening up items or for washing new items before wearing for the first time.
Mixed Load
For mixed items of laundry made of various hard-wearing and easy-care fabrics
Sportswear
For washing functional clothing and sports wear made from microfibre and synthetics. Reduced creasing and additional rinse cycle.
* Depending on the model and the programme.

Washing Programmes***AllergyPlus**

For washing fabrics with increased hygiene requirements or those that will be used by allergy sufferers. The temperature remains constant during the washing process. More intensive rinsing with increased water level. Forward-wearing and easy-care fabrics made from cotton or linen.

Night Wash

Particularly quiet wash programme with a reduced final spin. Sleep mode. Once the programme has finished, the display goes out, but can be reactivated by pressing any button.

* Depending on the model and the programme.

Drying Programmes **Intensive Dry**

Intensive drying for a & (robust fabrics), at 90°C.

 **Gentle Dry**

Gentle drying for & (easy-care fabrics), 60°C..

* Depending on the model and the programme.

Special Programmes* **/CLN (Fluff removal cycle)**

The drum must be empty.

Programme is designed to remove any fluff deposits. The clean symbol lights up and CLN appears on the display.

To run the Fluff Clean I (Fluff removal cycle):

1. Make sure that the drum is completely empty and close the door.
2. Turn the programme selector to Fluff Clean I (Fluff removal cycle)
3. Press the A (Start/Pause) button.

The Fluff Clean I (Fluff removal cycle) programme can also be run any time without prompting by the appliance.

* Depending on the model and the programme.

Special Programmes*

+ + Spin



An additional rinse cycle with a final spin. If the laundry is to be removed dripping wet, set the Spin speed to  (Rinse) before Programme start

+ Empty + Spin

Drain the rinsing water following a programme with  (Rinse hold)





1. Turn the programme selector to  +  Empty + Spin.
2. Set the spin speed to  (Rinse hold)
3. Press the Start/Pause 

Or drain and spin at the desired spin speed:

1. Turn the programme selector to  +  Empty + Spin
2. Press the B Spin button repeatedly until the desired spin speed is set.
3. Press the Start/Pause 

* Depending on the model and the programme.



Drying table

Recommended drying programme	Load (kg)	 (Cupboard dry) [h:min]	 (Iron-damp) [h:min]
 Intensive Dry	1,5	1:30	1:00
	2	1:30	1:00
	2,5	1:40	1:30
	3	2:10	1:50
	3,5	2:20	2:00
	4	2:30	2:10
 Gentle Dry	1,5	1:30	1:00
	2	1:40	1:00
	2,5	1:50	1:30
	3	2:10	1:40

i The values may diverge from those specified depending on over and undervoltage, fabric type, composition of the laundry to be dried, residual moisture in the fabric and the amount of the load.

Starching

Note: Laundry should not be treated with fabric softener.

1. Switch on the appliance.
2. Select the  **Rinse** programme.
3. Measure starch into compartment  in accordance with the manufacturer's instructions (clean first if necessary).
4. Touch the  (Start/Pause) button.

Dyeing/bleaching

Dye should only be used in normal household quantities. Salt may damage stainless steel. Always follow the dye manufacturer's instructions.

Do **not** use the appliance to bleach clothes.



Operating the appliance

Preparing the appliance

The appliance was tested before delivery. To remove residual water from the test procedure, the first wash cycle should be run without laundry using the Cottons 60°C programme.

Notes

- Never switch on a damaged appliance!
- Inform customer service!

1. Insert mains plug.

Warning

Risk of death from electric shock!

Risk of death if live parts are touched.

- Never pull out the mains plug by tugging the power cord.
- Insert/pull out the mains plug with dry hands only.

2. Turn the water tap on.

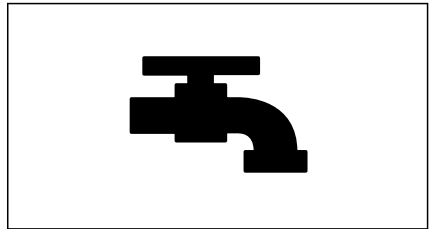

3. Open the appliance door.

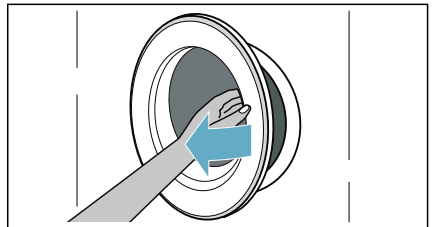

Select programme/switch on the appliance

Note: If you have activated the childproof lock, you must first deactivate it before you can set a programme.

Use the programme selector to select the required programme. The programme selector can be rotated in either direction.

The appliance is switched on.

The **programme default settings** for the selected programme alternately appear in the display panel:

- The maximum load and
- the duration of the programme and
- ...

Placing laundry into the drum

Insert the laundry.

Close the door.

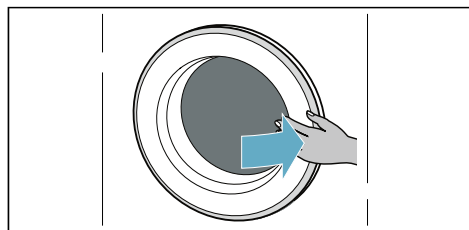
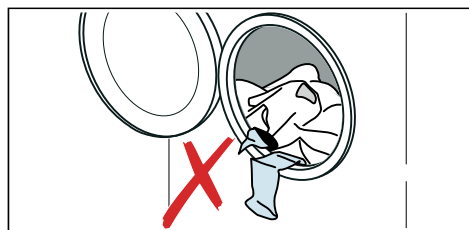

Notes

- Unfold and load presorted items of laundry. Mix large and small items. Washing items of different size distribute themselves better during the spin cycle. Individual items of washing may cause an unbalanced load.
- Observe the maximum specified load. Overfilling adversely affects the washing/drying result and promotes creasing. Make sure that no items of laundry are trapped between the door and the rubber seal, and close the door.

Dosing and adding detergent and care products

Caution!

Damage to the appliance

Detergents and agents for the pretreatment of laundry (e.g. stain remover, prewash sprays, etc.) may damage the surfaces of the appliance. Keep these agents away from the surfaces of the appliance. Using a damp cloth, immediately remove any fine spray residue and other residue/droplets.

Dosing

Dose the detergents and care products according to:

- water hardness (ask your water supply company),
- the manufacturer's specifications on the packaging,
- the amount of laundry,
- soiling.

Filling the dispensers

1. Pull out the detergent drawer.

⚠ Warning
Eye / skin irritation!

If the detergent drawer is opened while the appliance is running, detergent/care product may run out. Carefully open the drawer.

If detergent/care product comes into contact with eyes or skin, rinse thoroughly.

If accidentally swallowed, seek medical advice.

2. Pour in detergent and/or cleaning product.

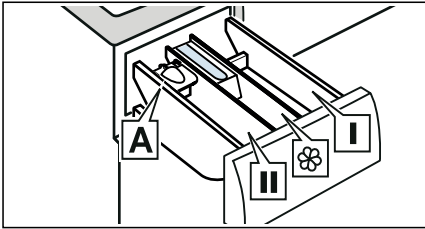

- | | |
|--------------|---|
| Dispenser I | Disinfectant for pretreat and clothing disinfectant. (only for the appliance with pretreat and disinfectant function) |
| Dispenser | Softener, starch. Do not exceed the maximum load. |
| Dispenser II | Detergent for main wash, water softener, bleach, stain remover. |
| Dispenser A* | For dosing liquid detergent. |

*depending on the model

Notes

- Always follow the manufacturer's instructions when dosing all detergents, cleaning aids, care products and cleaning agents.
- Dilute viscous fabric softener and fabric conditioner with water. This will prevent blockages.

- Be careful when opening the detergent drawer while the appliance is running.

Measuring aid A* for liquid detergent

*depending on the model

Position the measuring aid A for measuring the correct amount of liquid detergent:

1. Pull out the detergent drawer. Press down the insert and fully remove the drawer.

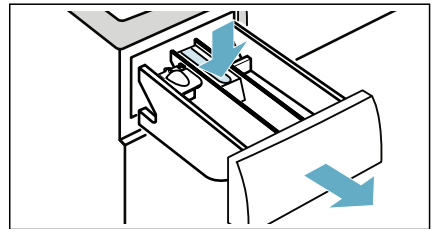

2. Slide the measuring aid forwards, fold it down and click it into place.

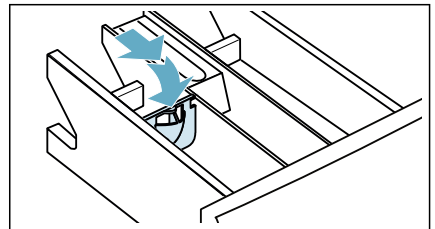

3. Reinsert the drawer.

Note: Do not use the measuring aid for gel detergents and washing powder, or for programmes with pretreat or when "Finish in" time is selected.

Childproof lock

You can lock the appliance to prevent the functions you have set from being changed inadvertently. To do this, activate the childproof lock.

To activate or deactivate the childproof lock:

After the programme starts, press and hold the Option button and Set button.

-  (**Childproof lock**) lights up: The childproof lock is activated.

Note: When the programme ends, the door is unlocked.  (**Childproof lock**) remain on to remind you to deactivate the childproof lock.

Removing laundry/switching off the appliance

1. Set programme selector to Off **Off**.
2. Open the door and remove the laundry.
3. Turn off the water tap.

Note: Not required for Aqua-Stop models.

Notes

- Do not leave any items of laundry in the drum. They may shrink in the next wash or discolour another item.
- Remove any foreign objects from the drum and the rubber seal – risk of rusting.
- Wipe the rubber seal dry.

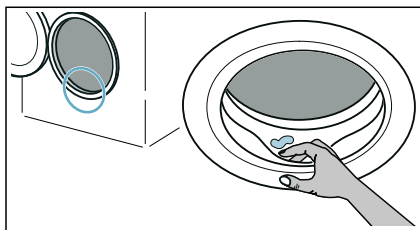

- Leave the door and detergent drawer open so that any residual water can evaporate.
- Always wait until the programme ends, as the appliance could still be locked. Then switch the appliance on and wait for it to unlock.

Sensors

Unbalanced load detection system

The automatic unbalanced load detection system detects imbalances and ensures even distribution of the laundry by repeatedly starting and stopping drum spinning.

If the laundry is extremely unevenly distributed, the spin speed is reduced or the spin cycle is not performed for safety reasons.

Note: Place large and small items of laundry evenly in the drum.

Cleaning and maintenance

Warning

Risk of death!

There is a risk of electric shock if touch live components.
Turn the programme selector to Off **Off**.
Pull out the mains plug.

Caution!

Fire and explosion hazard!

Toxic vapours can be produced by cleaning agents that contain solvents, e.g. cleaning solvent.
Do not use cleaning agents that contain solvents.

Caution!

The appliance may be damaged!

Cleaning agents that contain solvents, e.g. cleaning solvent, can damage surfaces and components in the appliance.
Do not use cleaning agents that contain solvents.

Appliance housing/control panel

- Remove the detergent residue immediately.
- Wipe the housing and the control panel with a soft, damp cloth.
- Do not use abrasive cloths, sponges or detergents (stainless steel cleaner).
- Do not clean the appliance with a water jet.

Drum

Use chlorine-free cleaning agents, do not use steel wool.

If there are odours in the appliance, or to clean the drum, run the Fluff Clean programme without laundry.

Descaling

Descaling should not be necessary if the detergent is measured out correctly. However, if it is required, follow the manufacturer's instructions for the descaling agent. Suitable descalers can be obtained via our website or from customer services.

Detergent drawer and housing

If the appliance contains detergent or fabric softener residues:

1. Pull out the detergent drawer. Press down the insert and fully remove the drawer.

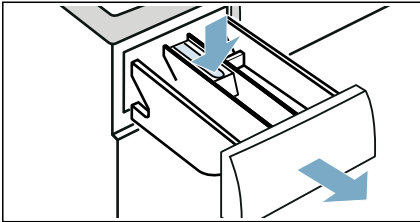

2. To remove the insert: Push the insert upwards from below with your finger.

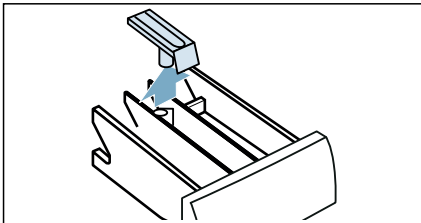

3. Clean the detergent dispenser tray and insert with water and a brush, and dry it. Clean the inside of the housing as well.

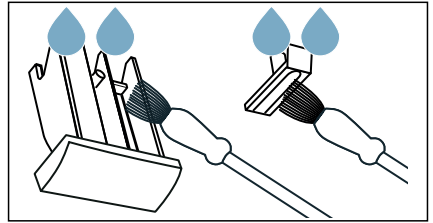

4. Fit the insert and lock it in place (push the cylinder onto the guide pin).

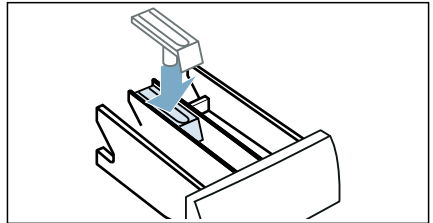

5. Push in the detergent drawer.

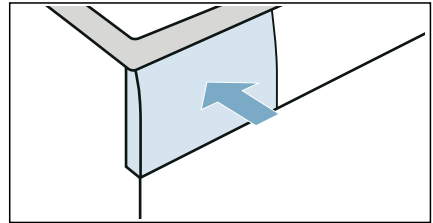

Note: Leave the detergent drawer open so that any residual water can evaporate.

Drain pump is blocked

Note: Turn the water tap off to prevent more water from flowing in and to ensure that it is drained via the pump.

Warning

Risk of scalding!

When you wash at high temperatures, the water gets very hot. If you come into contact with the hot water, you may be scalded.

Allow the water to cool down first.

1. Switch off the appliance. Pull out the mains plug.
2. Open the service flap. Use a screwdriver to release the lock pins

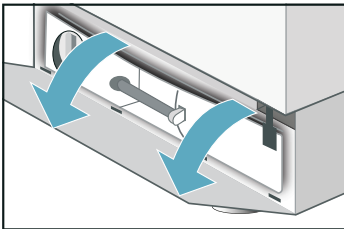
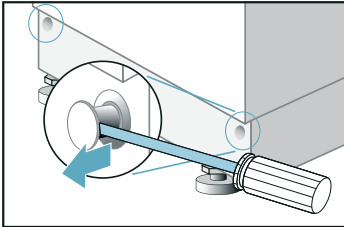

3. Take the drain hose out of the retainer. Remove the sealing cap and pour the water out into a suitable container. The container for the drained water may have to be emptied several times. Replace the sealing cap and place the drain hose back in the retainer.

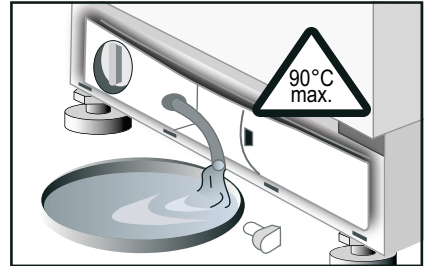

4. Carefully unscrew the pump cover; residual water may leak out. Clean the pump housing and remove any foreign objects. The impeller in the drain pump must be able to rotate.

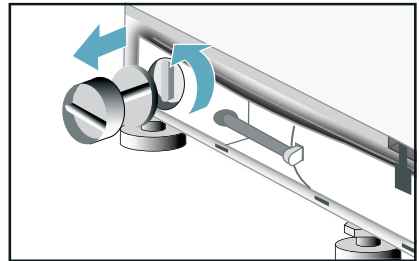

5. Replace the pump cover and screw firmly in place. Place the kick panel in the 4 clip-in slots and secure to the housing using the lock pins.

The drain hose at the siphon is blocked

1. Set the program selector to Off. Pull out the mains plug.
2. Loosen the hose clamp. Carefully remove the drain hose; residual water may leak out.
3. Clean the drain hose and siphon connecting piece.

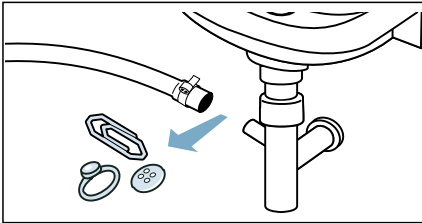

4. Re-attach the drain hose and secure the connection point using the hose clamp.

Filter in the water supply is blocked

Release water pressure in the supply hose:

1. Turn off the water tap.
2. Select the  Rinse@Spin button and start the program. Allow to run for approx. 40 seconds.
3. Set the program selector to Off
4. Pull out the mains plug.

Clean the filters:

1. Disconnect the hose from the rear of the appliance.

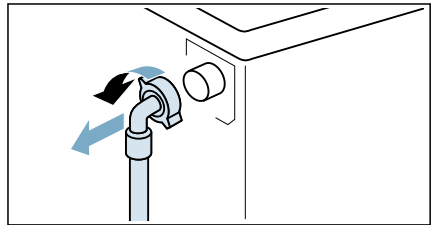

2. Use pliers to remove the filter.

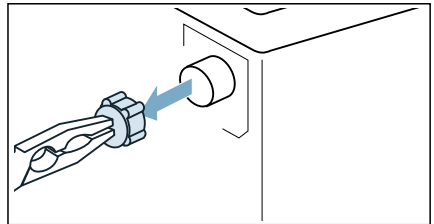

3. Clean the filter with a small brush.

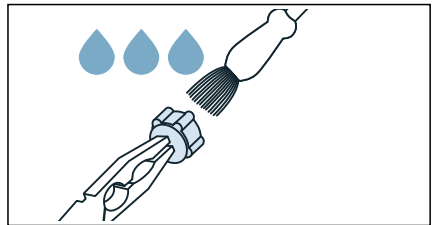

4. Connect the hose and check for leaks.

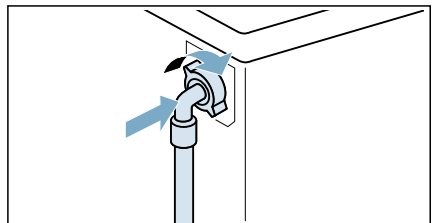

Faults and what to do about them

Emergency release

E.g. power outage or in the event of a loss of power

The programme continues when the power supply is restored.

However, if the laundry has to be removed, the appliance door can be opened as follows:

Warning

Risk of scalding!

When you are washing at high temperatures, there is a risk of scalding if you come into contact with hot water and laundry.

If possible, leave it to cool down first.

Caution! **Risk when reaching into/gripping the rotating drum!**

You may injure your hands if you reach into the drum while it is turning. Do not reach into the drum when it is turning.

Caution! **Water damage!**

Any escaping water may cause water damage.

Do not open the door if water can be seen through the glass.

1. Switch off the appliance. Pull out the mains plug.
2. Drain the water → *Page 43*
3. Pull the emergency release downwards with a tool and open the door on the same time.



Information on the display panel

Fault code	
<i>OPEN</i>	The door is not properly closed. Close the door.
<i>E I</i>	The water control system has been activated. Disconnect the appliance from the mains, turn off the tap and advise the after-sales service.
<i>ES</i>	Water is not entering the appliance. See the fault Water is not flowing in
<i>ES PUNP</i>	The water is not Drained. See the fault Water is not Drained
<i>UnLoAd</i>	Not a fault! The unbalanced load detection system has detected an unbalanced load caused by laundry items. The fluff removal cycle cannot start. Remove the laundry.
<i>HI End</i> <i>LO End</i>	Maximum or minimum drying load not taken into account. HI/End or LO/End flash alternately in the display. See information for the Drying result not satisfactory fault..
Other fault codes are only for use by the after-sales service. Make a note of the fault code to inform the after sales service.	

Faults and what to do about them

Fault	Possible cause	Remedial Action
Programme does not start	The Start/Pause ► button has not been pressed.	Press the Start/Pause ► button.
	A delayed start time has been selected..	Washer dryer starts on completion of the delay period. Change the “finished in time” if necessary.
	Power cut. The delayed start time that was selected has been cleared.	Reselect the delayed start time or start the programme immediately. Press the Start/Pause ► button.
	The door is not properly closed.	Close the door.
	Plug not inserted properly into socket.	Insert plug correctly
The maximum spin speed cannot be set.	The maximum spin speed depends on the programme selected.	Change programme as required.
The water is not Drained.	Drain hose is twisted..	Fit the Drain hose correctly.
	Detergent pump is blocked.	Clean the Drain pump .
Detergent residues in the detergent drawer.	Damp or lumpy detergent.	Clean and dry the detergent drawer .
		Use the measuring aid for liquid detergent.
Water is not flowing in.	The mains plug is not correctly plugged in.	Plug in the mains plug correctly.
	The door is not properly closed.	Close the door.
	The tap is not turned on.	Turn on the tap.
	The filter in the water supply hose is blocked.	Clean the filter in the water supply hose.
	The water supply hose is pinched or kinked.	Check the water inlet hose.
Intense vibrations during spinning.	The washer-dryer is not correctly levelled.	Level the washer-dryer .
	The transport safety bolts have not been removed.	Remove the transport safety bolts .
Washer-dryer fills with water and continuously drains it away.	Drain hose fitted too low.	Fit the Drain hose correctly.
No water can be seen in the drum.	Not a fault.	During certain programmes the water level is below the visible range.

Fault	Possible cause	Remedial Action
Water leaks from the bottom of the appliance.	Supply hose screw connection is leaking.	Tighten the screw connection.
	Drain hose is leaking.	Have the Drain hose replaced by the after-sales service.
Foam escapes from detergent drawer.	Too much detergent has been used.	Only use detergent which is correct for textiles, and suitable for use in automatic washing machines. Make sure that you use the correct dosage.
Several attempts to start spinning.	Not a fault. The unbalanced load detection system attempts to redistribute an unbalanced load by starting to spin several times.	Always wash large and small items together.
Washing results not satisfactory.	Uncleaned areas worse than expected..	√ (Prewash) Pretreat stains if necessary.
	Too little or incorrect detergent used.	Use the correct dosage of a suitable detergent, in accordance with the manufacturer's instructions.
	Maximum load exceeded.	Select the load appropriate for the programme.
Detergent residues on the washing.	Some phosphate-free detergents contain water-insoluble residues which appear on washing as light specks.	Rinse the laundry again or change to using liquid detergent. Brush the laundry after it has dried.
Grey residues on the washing.	Soiling caused by ointments, grease or oil.	Wash the laundry using the maximum detergent dosage and the maximum permissible temperature – see the care label.
Programme terminated unexpectedly.	Press the Start/Pause ▷ button elected accidentally.	Turn on the tap.
Drying result not satisfactory.	The laundry clings to the sides of the drum after being spun	Loosen up the laundry by hand; start the drying programme.
	Closed tap	Turn on the tap
	Selected drying time too short	Select the drying time according to the Load.
	Maximum or minimum load not taken into account	Once the programme has ended: adjust the load quantity, select a suitable drying programme and restart.
Spinning during drying.	No fault	"Thermo spin", which is for energy-efficient drying, starts after a drying time of approx. 10 minutes.

Fault	Possible cause	Remedial Action
The fabric softener is not completely flushed in or too much water remains in the compartment.	The fabric softener compartment insert is not correctly attached or is blocked.	If necessary, clean the fabric softener compartment insert and fit it correctly in compartment.
The laundry is not dried.	The tap is turned off.	Turn on the tap.
	The load is too large.	Reduce the load size.
	The drying time is too short.	Select a suitable drying time.
No display on the display panel.	Power cut	The programme continues when power is restored. If you wish to remove the laundry during a power cut, you must first Drain out the water. Check whether: - the plug is plugged into the socket correctly, - the circuit breaker (fuse) has tripped; if it has, call the after-sales service
The door cannot be opened.	Rinse hold has been selected	Select the programme  Empty + Spin and press the Start/Pause  button.
	The programme is running or the door is locked for safety reasons	Wait until End appears on the display panel.
	Power cut.	Unlock the door mechanically
Emergency release	<p>To release the door mechanically in the event of a power cut:</p> <ul style="list-style-type: none"> ■ turn the programme selector to Off and unplug the mains plug from the socket ■ open the base panel and Drain out the water ■ pull the emergency release downwards and open the door at the same time. <p>Before opening the door, make sure that there is no water or hot detergent solution in the washer dryer.</p> <p>Under no circumstances open the door with the emergency release while the drum is still turning.</p>	
<p>If you cannot correct a fault yourself (switching on/off) or a repair is required: - Turn the programme selector to Off and unplug the mains plug from the socket. - Turn off the tap and call the after-sales service -> page 24.</p>		



Customer Service

If you have any queries on use, are unable to rectify faults on the appliance yourself or if your appliance needs to be repaired, contact Customer Service.

You can solve many problems yourself by consulting the information on eliminating faults in this instruction manual or on our website. If this is not the case, contact our Customer Service

We will always find an appropriate solution and try to avoid unnecessary visits being made by a Customer Service technician.

With any warranty claims we will make sure that your appliance is repaired by trained Customer Service technicians using original spare parts, including after the manufacturer's warranty has expired.

For safety reasons repairs to the appliance should only be carried out by trained specialist staff. The warranty claim becomes void if repairs or interventions have been carried out by persons not authorised by us for that purpose or if our appliances have been fitted with spare, supplementary or accessory parts that were not genuine parts and then resulted in a defect.

Function-relevant genuine spare parts according to the corresponding Eco-design Order can be obtained from Customer Service for a period of at least 10 years from the date on which your appliance was placed on the market within the European Economic Area.

Note: Under the terms of the manufacturer's warranty the use of Customer Service is free of charge.

Detailed information on the warranty period and terms of warranty in your country is available from our Customer Service, your retailer or on our website.

If you contact Customer Service, you will require the product number (E-Nr.) and the production number (FD) of your appliance.

The contact details for Customer Service can be found in the enclosed Customer Service directory or on our website.

Product number (E-Nr.) and production number (FD)

You can find the product number (E-Nr.) and the production number (fd) on the appliance's rating plate.

Depending on the model, the rating plate is located:

- On the inside of the door
- On the inside of the maintenance flap.
- On the rear of the appliance.

Make a note of your appliance's details and the Customer Service telephone number to find them again quickly.

More information about your model can be found online at <https://www.bsh-group.com/energylabel>* This web address is linked to the official EU EPREL product database. At the time of printing its web address had not yet been published. Please then follow the instructions on searching for models. The model identifier is made up of the characters before the slash in the product number (E-Nr.) on the rating plate. Alternatively you can also find the model identifier in the first line of the EU energy label.

Trust the expertise of the manufacturer. Contact us. By doing so, you can be sure that the repairs are carried out by trained service personnel using genuine spare parts.

* Only applies to countries in the European Economic Area.



Consumption values

The following information is provided in accordance with the EU-Ecodesign-Regulation. The values given for programs other than the Eco 40-60 are indicative only and were determined in accordance with the applicable standard EN60456 and EN62512.

Automatic drying machine

Programme	rated capacity [kg]	energy consumption [kWh/cycle] *	water consumption [l/cycle] *	Programme duration [h:min] *	maximum temperature [°C] * 5min	spin speed [rpm] *	remaining moisture [%] *
Eco 40-60 **	7	1,02	49	2:50	46	1400	48
Eco 40-60 **	3,5	0,70	43	2:40	36	1400	49
Eco 40-60 **	2	0,50	39	2:30	32	1400	54
Eco 40-60 + (wash&dry) + * (Cupboard dry)**	4	3,08	75	5:30	36	1400	-
Eco 40-60 + (wash&dry) + * (Cupboard dry)**	2	2,04	58	4:10	32	1400	-
Cottons 20°C	7	0,24	62	1:51	20	1400	53
Cottons 40°C	7	0,83	62	1:51	40	1400	53
Cottons 40°C + (Prewash)	7	1,02	78	2:18	40	1400	53
Cottons 60°C	7	1,11	62	1:51	55	1400	53
Easy Care 40 °C	3,5	0,62	50	1:43	40	1000	30
Mixed Load 40°C	3	0,40	36	0:50	40	1200	57
Wool 30 °C	2	0,20	49	0:47	30	600	55

* Observed values may deviate from the indicated values due to influence of water pressure, hardness and inlet temperature, ambient temperature, type, amount and soiling of laundry, detergent used, fluctuations in power supply and selected additional functions.

** Test program according to the EU-Ecodesign-Regulation and EU-Energy Label-Regulation with cold water (15°C).

The following information is provided in accordance with the EU-Ecodesign-Regulation. The values given for programs other than the Eco 40-60 are indicative only and were determined in accordance with the applicable standard EN60456 and EN62512.

Timed drying machine

Programme	rated capacity [kg]	energy consumption [kWh/cycle] *	water consumption [l/cycle] *	Programme duration [h:min] *	maximum temperature [°C] * 5min	spin speed [rpm] *	remaining moisture [%] *
Eco 40-60 **	7	1,02	49	2:50	46	1400	48
Eco 40-60 **	3,5	0,70	43	2:40	36	1400	49
Eco 40-60 **	2	0,50	39	2:30	32	1400	54
Eco 40-60 + (wash&dry) + ☒ (Cupboard dry)**	4	3,09	75	5:30	36	1400	-
Eco 40-60 + (wash&dry) + ☒ (Cupboard dry)**	2	2,025	58	4:10	32	1400	-
Cottons 20°C	7	0,24	62	1:51	20	1400	53
Cottons 40°C	7	0,83	62	1:51	40	1400	53
Cottons 40°C + ⌞ (Prewash)	7	1,02	78	2:18	40	1400	53
Cottons 60°C	7	1,11	62	1:51	55	1400	53
Easy Care 40 °C	3,5	0,62	50	1:43	40	1000	30
🧶 Wool Cold	2	0,10	49	0:47	-	600	55
🧶 Wool 30 °C	2	0,20	49	0:47	30	600	55
* Observed values may deviate from the indicated values due to influence of water pressure, hardness and inlet temperature, ambient temperature, type, amount and soiling of laundry, detergent used, fluctuations in power supply and selected additional functions.							
** Test program according to the EU-Ecodesign-Regulation and EU-Energy Label-Regulation with cold water (15°C).							



Technical data

Dimensions:

820 mm x 595 mm x 584 mm
(height x width x depth)

Weight:

85 kg

Mains connection:

Nominal voltage 220-240V, 50 Hz

Minimum installation protection (≡)10 A

Nominal power 1900-2300 W

Water pressure:

50–900 kPa (0,5–9 bar)



Aqua-Stop warranty

Only for appliances with Aqua-Stop

In addition to warranty claims against the vendor based on the purchase agreement and to our appliance warranty, we will provide compensation under the following conditions:

1. If water damage is caused due to a fault in our Aqua-Stop system, we will compensate domestic customers for the damage caused.
2. The liability guarantee is valid for the service life of the appliance.
3. It is a prerequisite of all warranty claims that the appliance with Aqua-Stop must have been installed and connected correctly in accordance with our instructions; this also includes a correctly fitted Aqua-Stop extension (genuine accessories). Our warranty does not cover defective feed lines or fittings leading to the Aqua-Stop connection at the tap.
4. Appliances with Aqua-Stop do not need to be supervised during operation, nor secured afterwards by turning off the tap. The tap only needs to be turned off if you are away from home for a long period, e.g. for several weeks' holiday.



A series of horizontal lines for writing, starting with a solid line immediately below the pencil icon, followed by a dashed line, and then a series of solid lines spaced evenly down the page.

Repair order and advice in the event of faults

GB 0344 892 8989 Calls charged at local or mobile rate.

IE 01450 2655 0.03 € per minute at peak.
Off peak 0.0088 € per minute.

You can find the contact information for all countries in the attached after-sales service directory:

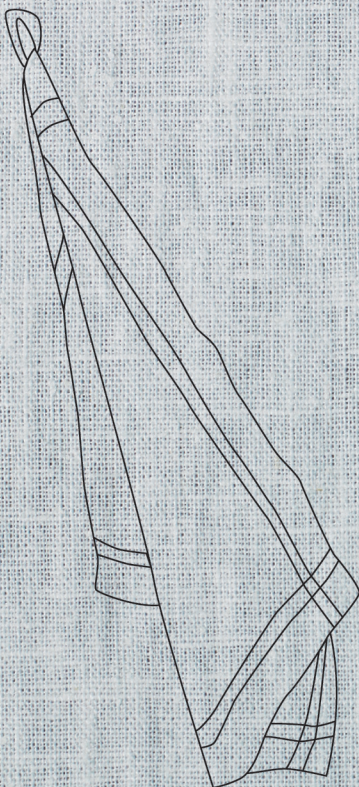

REGISTER YOUR PRODUCT
ONLINE NEFF-HOME.COM



Constructa NEFF Vertriebs-GmbH |
Carl-Wery-Straße 34 | 81739 Munich | Germany



9001581148
en
19291040001 / 0103